

IRF6718L2TRPbF

IRF6718L2TR1PbF

DirectFET™ Power MOSFET ②

Typical values (unless otherwise specified)

V_{DS}	V_{GS}	$R_{DS(on)}$	$R_{DS(on)}$		
25V max	±20V max	0.50mΩ@10V	1.0mΩ@4.5V		
$Q_{g\ tot}$	Q_{gd}	Q_{gs2}	Q_{rr}	Q_{oss}	$V_{gs(th)}$
64nC	20nC	9.4nC	67nC	50nC	1.9V

- RoHS Compliant Containing No Lead and Bromide ①
- Dual Sided Cooling Compatible ①
- Ultra Low Package Inductance
- Very Low $R_{DS(on)}$ for Reduced Conduction Losses
- Optimized for Active O-Ring / Efuse Applications
- Compatible with existing Surface Mount Techniques ①

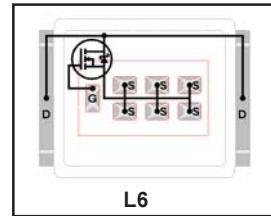

Applicable DirectFET Outline and Substrate Outline ①

S1	S2	SB		M2	M4		L4	L6	L8	
----	----	----	--	----	----	--	----	-----------	----	--

Description

The IRF6718L2TRPbF combines the latest HEXFET® Power MOSFET Silicon technology with the advanced DirectFET™ packaging to achieve the lowest on-state resistance in a package that has the footprint of a D-pak. The DirectFET package is compatible with existing layout geometries used in power applications, PCB assembly equipment and vapor phase, infra-red or convection soldering techniques, when application note AN-1035 is followed regarding the manufacturing methods and processes. The DirectFET package allows dual sided cooling to maximize thermal transfer in power systems.

The IRF6718L2TRPbF has extremely low Si $R_{ds(on)}$ coupled with ultra low package resistance to minimize conduction losses. The IRF6718L2TRPbF has been optimized for parameters that are critical in reliable operation on Active O-Ring / Efuse / hot swap applications.

Absolute Maximum Ratings

	Parameter	Max.	Units
V_{DS}	Drain-to-Source Voltage	25	V
V_{GS}	Gate-to-Source Voltage	±20	V
$I_D @ T_A = 25^\circ C$	Continuous Drain Current, $V_{GS} @ 10V$ ③	61	A
$I_D @ T_A = 70^\circ C$	Continuous Drain Current, $V_{GS} @ 10V$ ③	52	
$I_D @ T_C = 25^\circ C$	Continuous Drain Current, $V_{GS} @ 10V$ ④	270	
I_{DM}	Pulsed Drain Current ⑤	490	A
E_{AS}	Single Pulse Avalanche Energy ⑥	530	mJ
I_{AR}	Avalanche Current ⑤	49	A

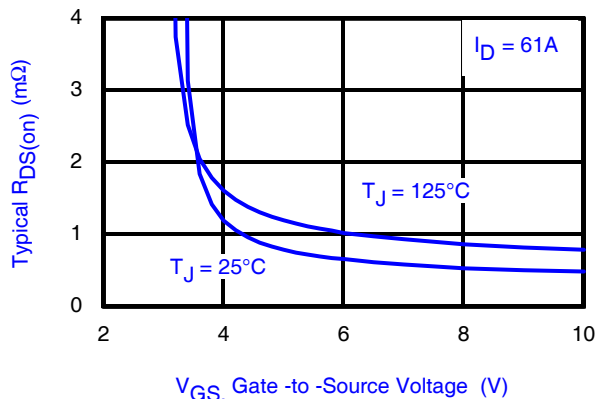

Fig 1. Typical On-Resistance vs. Gate Voltage

Notes:

- ① Click on this section to link to the appropriate technical paper.
- ② Click on this section to link to the DirectFET Website.
- ③ Surface mounted on 1 in. square Cu board, steady state.

www.irf.com

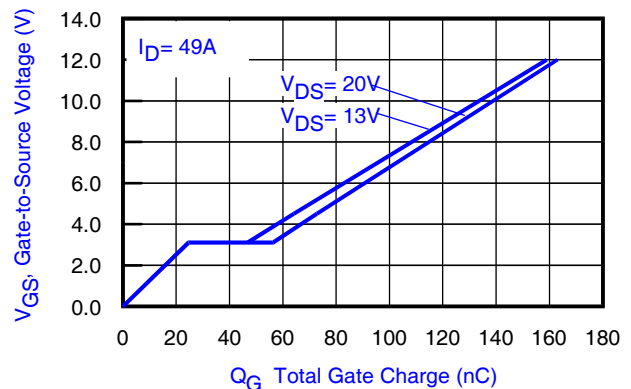

Fig 2. Typical Total Gate Charge vs. Gate-to-Source Voltage

- ④ T_C measured with thermocouple mounted to top (Drain) of part.
- ⑤ Repetitive rating; pulse width limited by max. junction temperature.
- ⑥ Starting $T_J = 25^\circ C$, $L = 0.44mH$, $R_G = 25\Omega$, $I_{AS} = 49A$.

Static @ $T_J = 25^\circ\text{C}$ (unless otherwise specified)

	Parameter	Min.	Typ.	Max.	Units	Conditions
BV_{DSS}	Drain-to-Source Breakdown Voltage	25	—	—	V	$V_{GS} = 0V, I_D = 250\mu A$
$\Delta BV_{DSS}/\Delta T_J$	Breakdown Voltage Temp. Coefficient	—	11	—	mV/°C	Reference to $25^\circ\text{C}, I_D = 1\text{mA}$
$R_{DS(on)}$	Static Drain-to-Source On-Resistance	—	0.50	0.70	m Ω	$V_{GS} = 10V, I_D = 61A$ ⑦
		—	1.0	1.4		$V_{GS} = 4.5V, I_D = 49A$ ⑦
$V_{GS(th)}$	Gate Threshold Voltage	1.35	1.90	2.35	V	$V_{DS} = V_{GS}, I_D = 150\mu A$
$\Delta V_{GS(th)}/\Delta T_J$	Gate Threshold Voltage Coefficient	—	-7.6	—	mV/°C	
I_{DSS}	Drain-to-Source Leakage Current	—	—	1.0	μA	$V_{DS} = 20V, V_{GS} = 0V$
		—	—	150		$V_{DS} = 20V, V_{GS} = 0V, T_J = 125^\circ\text{C}$
I_{GSS}	Gate-to-Source Forward Leakage	—	—	100	nA	$V_{GS} = 20V$
	Gate-to-Source Reverse Leakage	—	—	-100		$V_{GS} = -20V$
g_{fs}	Forward Transconductance	820	—	—	S	$V_{DS} = 13V, I_D = 49A$
Q_g	Total Gate Charge	—	64	96	nC	$V_{DS} = 13V$ $V_{GS} = 4.5V$ $I_D = 49A$ See Fig. 18
Q_{gs1}	Pre-V _{th} Gate-to-Source Charge	—	18	—		
Q_{gs2}	Post-V _{th} Gate-to-Source Charge	—	9.4	—		
Q_{gd}	Gate-to-Drain Charge	—	20	—		
Q_{godr}	Gate Charge Overdrive	—	16.6	—		
Q_{sw}	Switch Charge ($Q_{gs2} + Q_{gd}$)	—	29.4	—		
Q_{oss}	Output Charge	—	50	—	nC	$V_{DS} = 16V, V_{GS} = 0V$
R_G	Gate Resistance	—	0.90	—	Ω	
$t_{d(on)}$	Turn-On Delay Time	—	67	—	ns	$V_{DD} = 13V, V_{GS} = 4.5V$ ⑦ $I_D = 49A$ $R_G = 6.8\Omega$
t_r	Rise Time	—	140	—		
$t_{d(off)}$	Turn-Off Delay Time	—	47	—		
t_f	Fall Time	—	53	—		
C_{iss}	Input Capacitance	—	8910	—	pF	$V_{GS} = 0V$ $V_{DS} = 13V$ $f = 1.0\text{MHz}$
C_{oss}	Output Capacitance	—	2310	—		
C_{rss}	Reverse Transfer Capacitance	—	1115	—		

Diode Characteristics

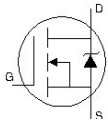
	Parameter	Min.	Typ.	Max.	Units	Conditions
I_S	Continuous Source Current (Body Diode)	—	—	61	A	MOSFET symbol showing the integral reverse p-n junction diode. 
I_{SM}	Pulsed Source Current (Body Diode) ⑤	—	—	490		
V_{SD}	Diode Forward Voltage	—	—	1.0	V	$T_J = 25^\circ\text{C}, I_S = 49A, V_{GS} = 0V$ ⑦
t_{rr}	Reverse Recovery Time	—	39	59	ns	$T_J = 25^\circ\text{C}, I_F = 49A$
Q_{rr}	Reverse Recovery Charge	—	67	100	nC	$di/dt = 200A/\mu s$ ⑦

Notes:

- ⑤ Repetitive rating; pulse width limited by max. junction temperature.
- ⑦ Pulse width $\leq 400\mu s$; duty cycle $\leq 2\%$.

Absolute Maximum Ratings

	Parameter	Max.	Units
$P_D @ T_A = 25^\circ\text{C}$	Power Dissipation ③	4.3	W
$P_D @ T_A = 70^\circ\text{C}$	Power Dissipation ③	3.0	
$P_D @ T_C = 25^\circ\text{C}$	Power Dissipation ④	83	
T_P	Peak Soldering Temperature	270	°C
T_J	Operating Junction and	-55 to + 175	
T_{STG}	Storage Temperature Range		

Thermal Resistance

	Parameter	Typ.	Max.	Units
$R_{\theta JA}$	Junction-to-Ambient ③	—	35	°C/W
$R_{\theta JA}$	Junction-to-Ambient ⑤	12.5	—	
$R_{\theta JA}$	Junction-to-Ambient ⑨	20	—	
$R_{\theta JC}$	Junction-to-Case ④⑩	—	1.8	
$R_{\theta J-PCB}$	Junction-to-PCB Mounted	1.0	—	
	Linear Derating Factor ③	0.029		W/°C

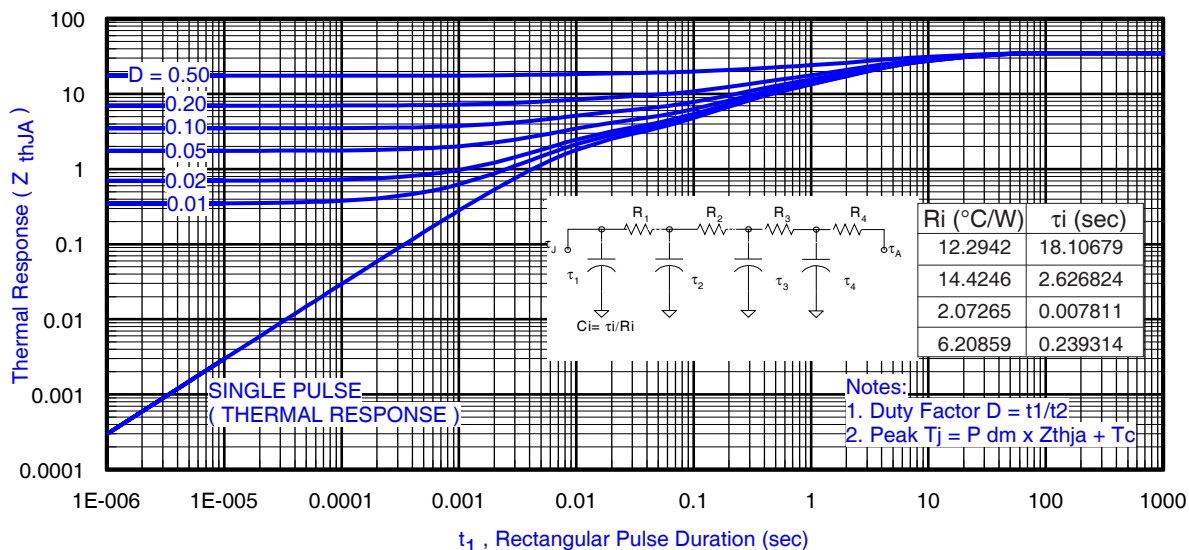
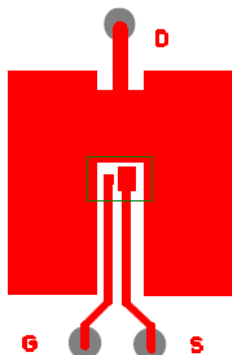

Fig 3. Maximum Effective Transient Thermal Impedance, Junction-to-Ambient ①
(At lower pulse widths Z_{thJA} & Z_{thJC} are combined)

Notes:

- ③ Surface mounted on 1 in. square Cu board, steady state.
- ④ T_C measured with thermocouple incontact with top (Drain) of part.
- ⑤ Used double sided cooling, mounting pad with large heatsink.
- ⑨ Mounted on minimum footprint full size board with metalized back and with small clip heatsink.
- ⑩ R_{θ} is measured at T_J of approximately 90°C .



③ Surface mounted on 1 in. square Cu board (still air).

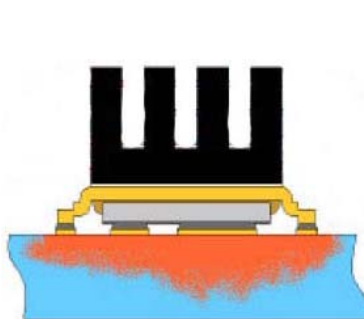

⑨ Mounted on minimum footprint full size board with metalized back and with small clip heatsink. (still air)

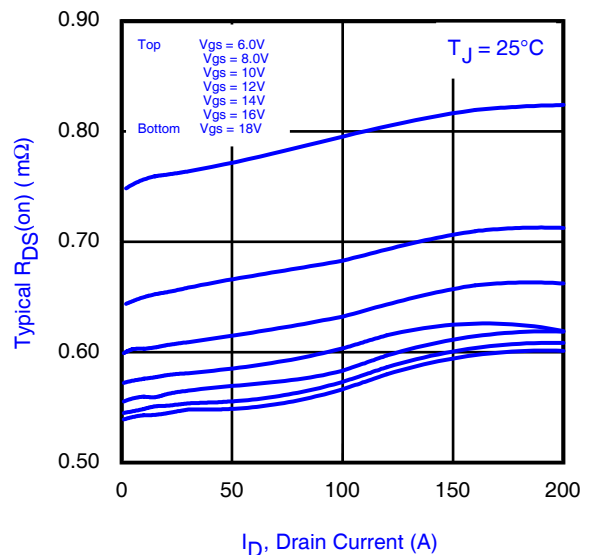
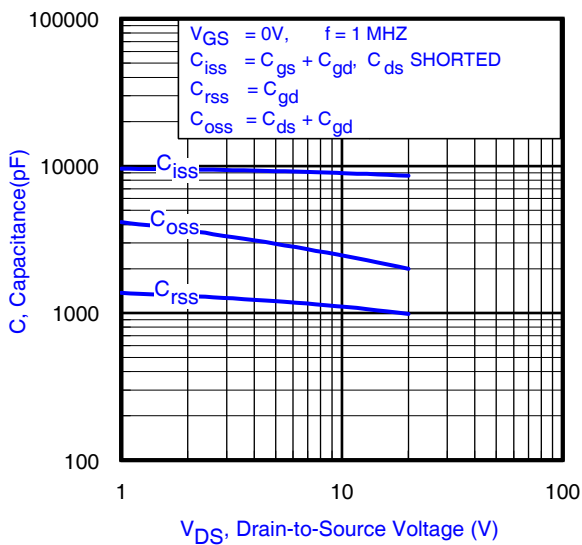
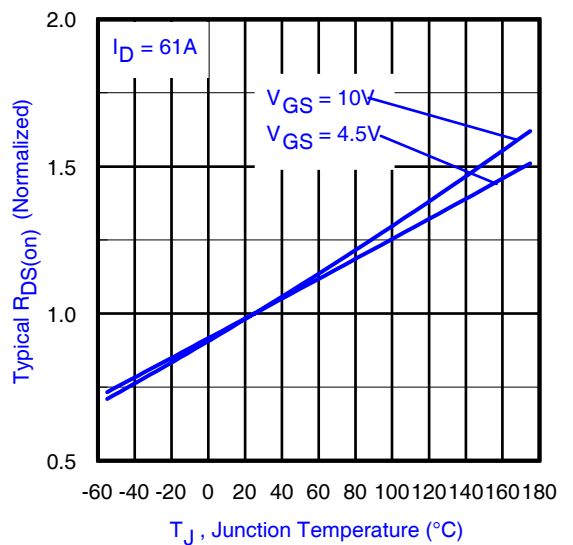
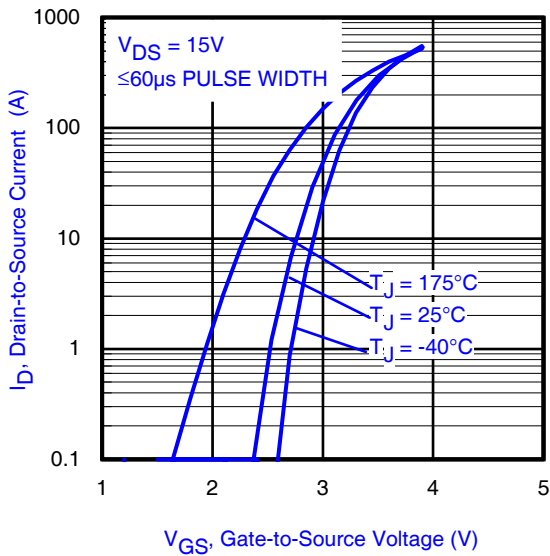
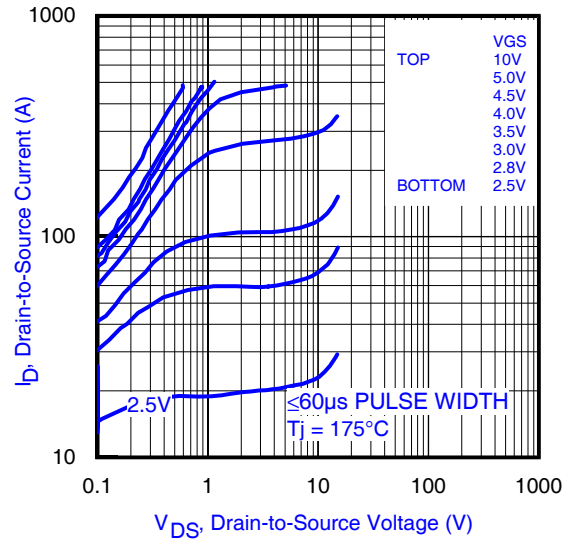
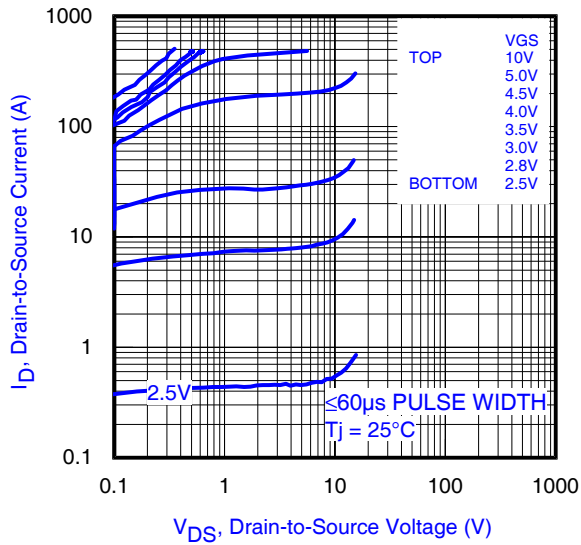

Fig 8. Typical Capacitance vs. Drain-to-Source Voltage

Fig 9. Typical On-Resistance vs. Drain Current and Gate Voltage

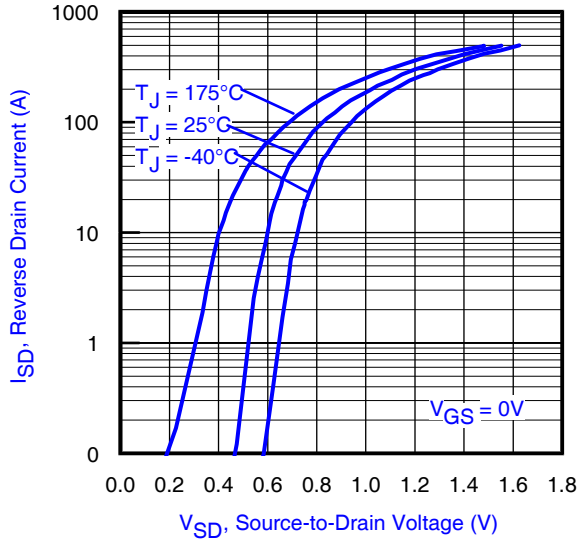

Fig 10. Typical Source-Drain Diode Forward Voltage

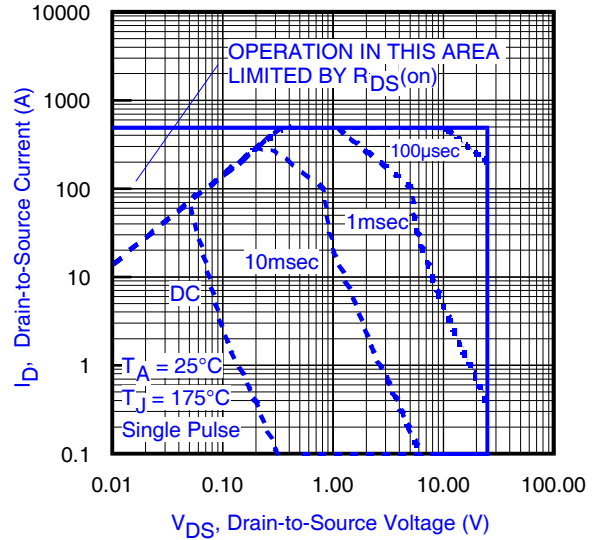

Fig 11. Maximum Safe Operating Area

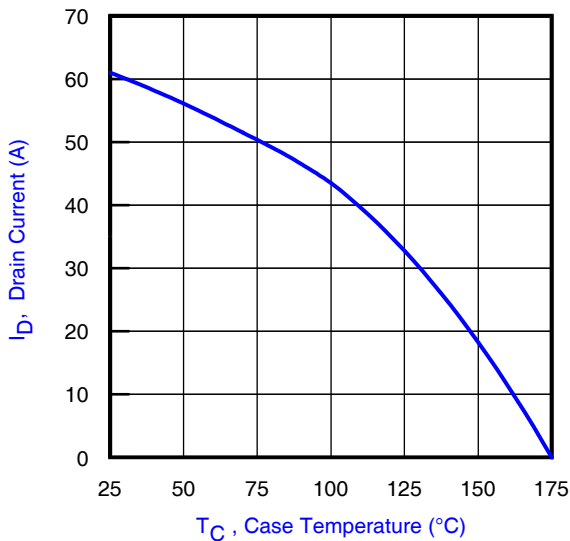

Fig 12. Maximum Drain Current vs. Case Temperature

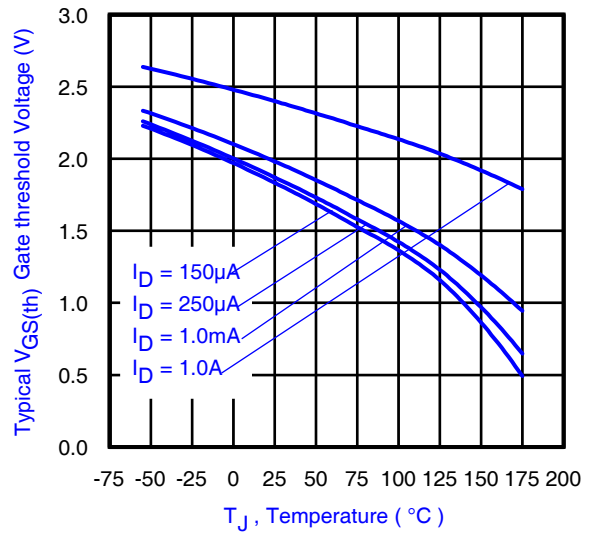

Fig 13. Typical Threshold Voltage vs. Junction Temperature

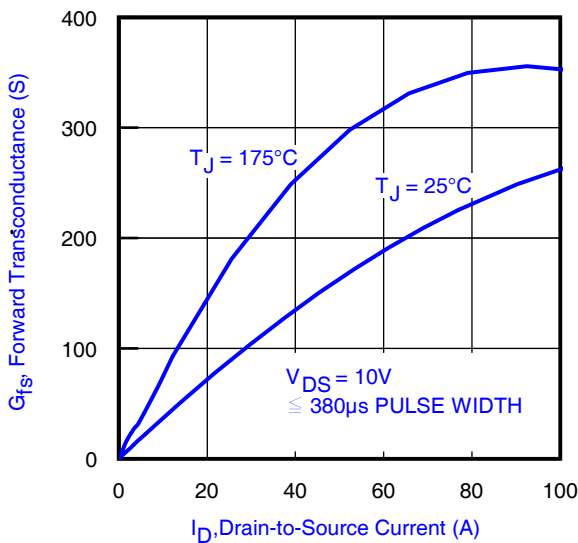

Fig 14. Typ. Forward Transconductance vs. Drain Current

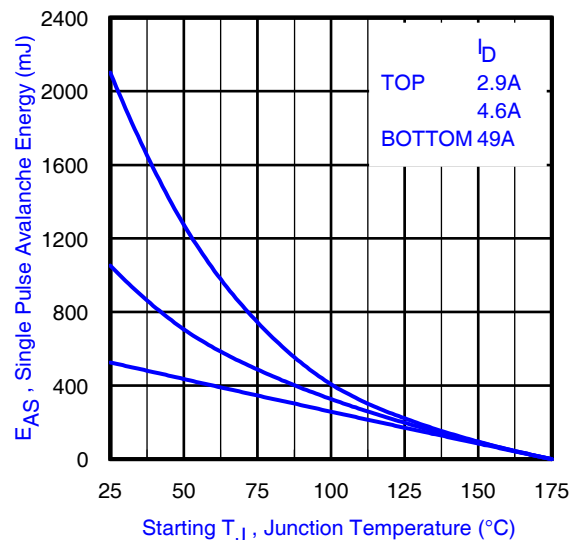

Fig 15. Maximum Avalanche Energy vs. Drain Current

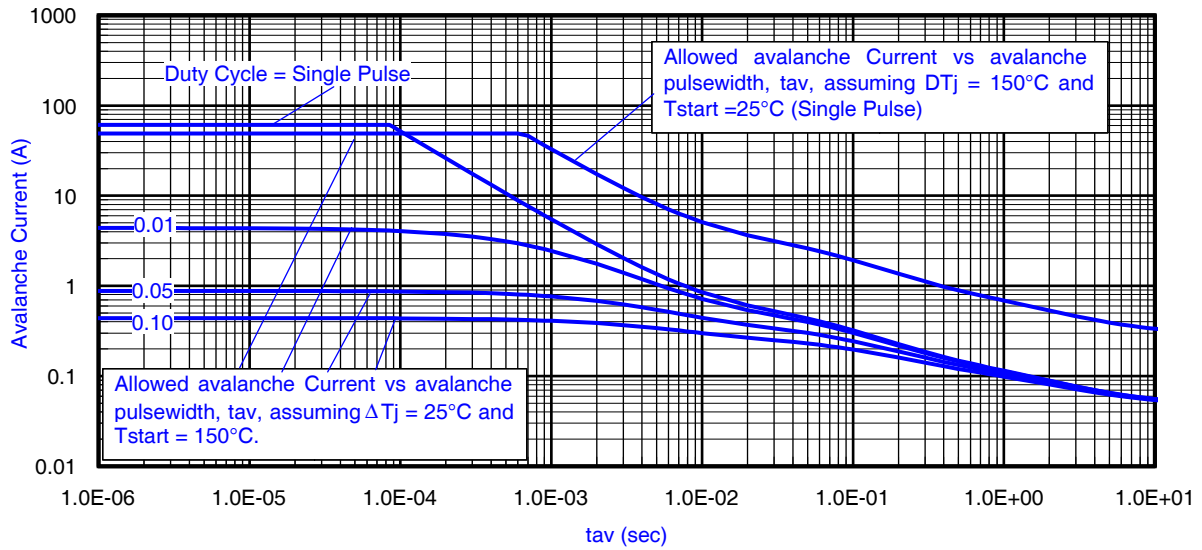

Fig 16. Typical Avalanche Current vs. Pulsewidth

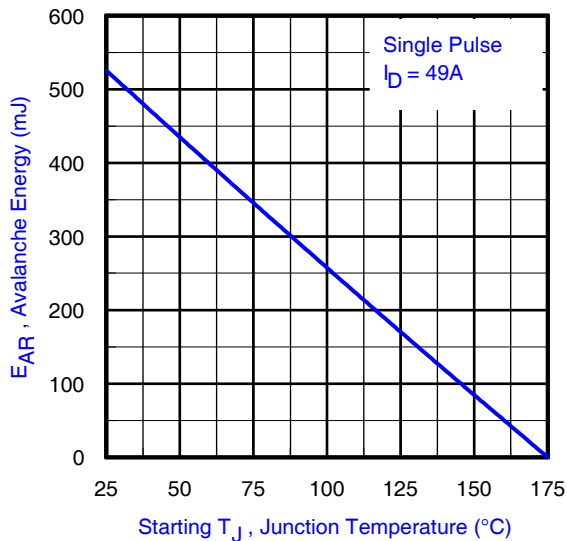

Fig 17. Maximum Avalanche Energy vs. Temperature

Notes on Repetitive Avalanche Curves , Figures 16, 17:
(For further info, see AN-1005 at www.irf.com)

1. Avalanche failures assumption:
Purely a thermal phenomenon and failure occurs at a temperature far in excess of T_{jmax} . This is validated for every part type.
2. Safe operation in Avalanche is allowed as long as T_{jmax} is not exceeded.
3. Equation below based on circuit and waveforms shown in Figures 19a, 19b.
4. $P_{D(ave)}$ = Average power dissipation per single avalanche pulse.
5. BV = Rated breakdown voltage (1.3 factor accounts for voltage increase during avalanche).
6. I_{av} = Allowable avalanche current.
7. ΔT = Allowable rise in junction temperature, not to exceed T_{jmax} (assumed as 25°C in Figure 16, 17).
 t_{av} = Average time in avalanche.
 D = Duty cycle in avalanche = $t_{av} \cdot f$
 $Z_{thJC}(D, t_{av})$ = Transient thermal resistance, see figure 11)

$$P_{D(ave)} = 1/2 (1.3 \cdot BV \cdot I_{av}) = \Delta T / Z_{thJC}$$

$$I_{av} = 2\Delta T / [1.3 \cdot BV \cdot Z_{th}]$$

$$E_{AS(AR)} = P_{D(ave)} \cdot t_{av}$$

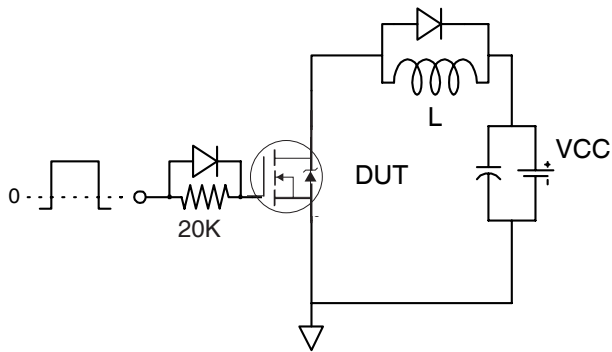

Fig 18a. Gate Charge Test Circuit

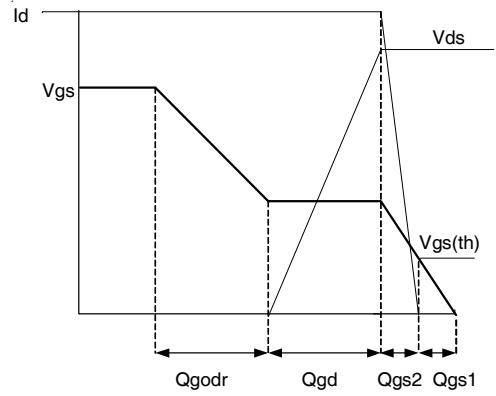

Fig 18b. Gate Charge Waveform

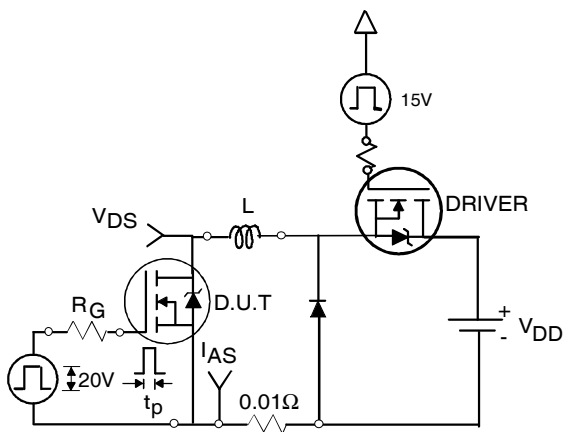

Fig 19a. Unclamped Inductive Test Circuit

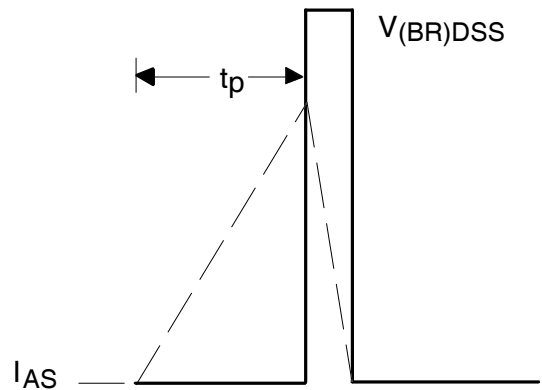

Fig 19b. Unclamped Inductive Waveforms

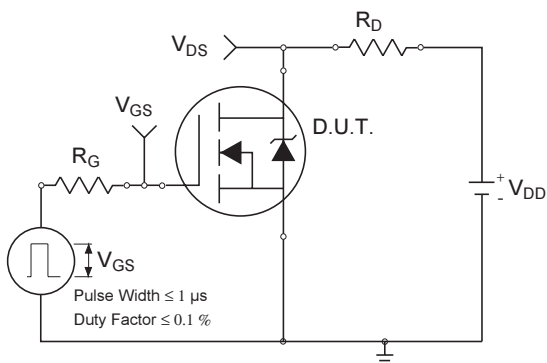

Fig 20a. Switching Time Test Circuit

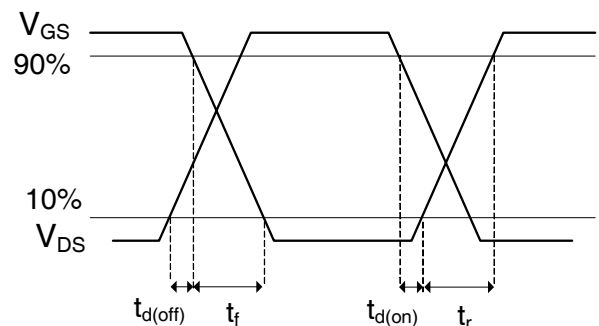

Fig 20b. Switching Time Waveforms

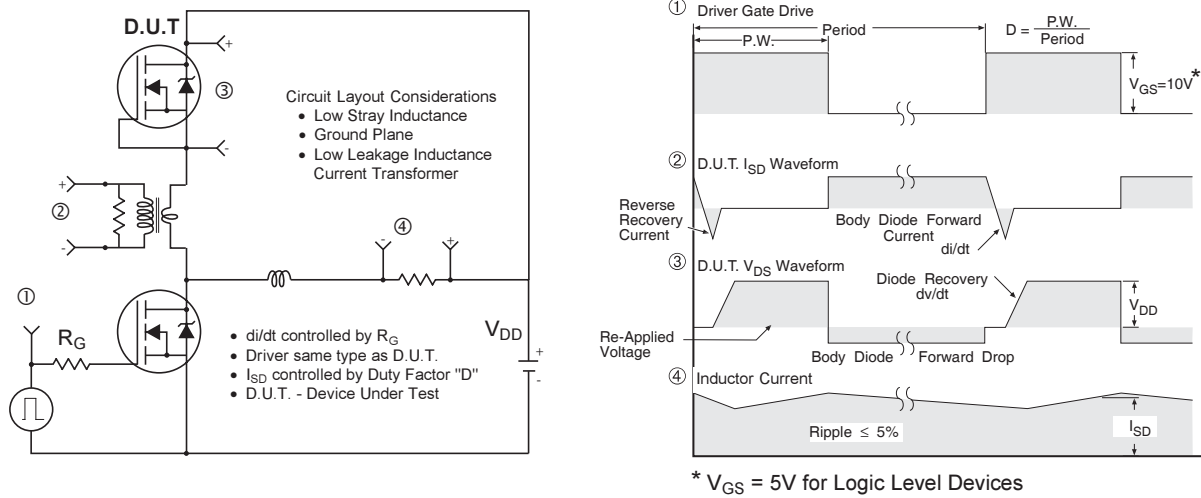
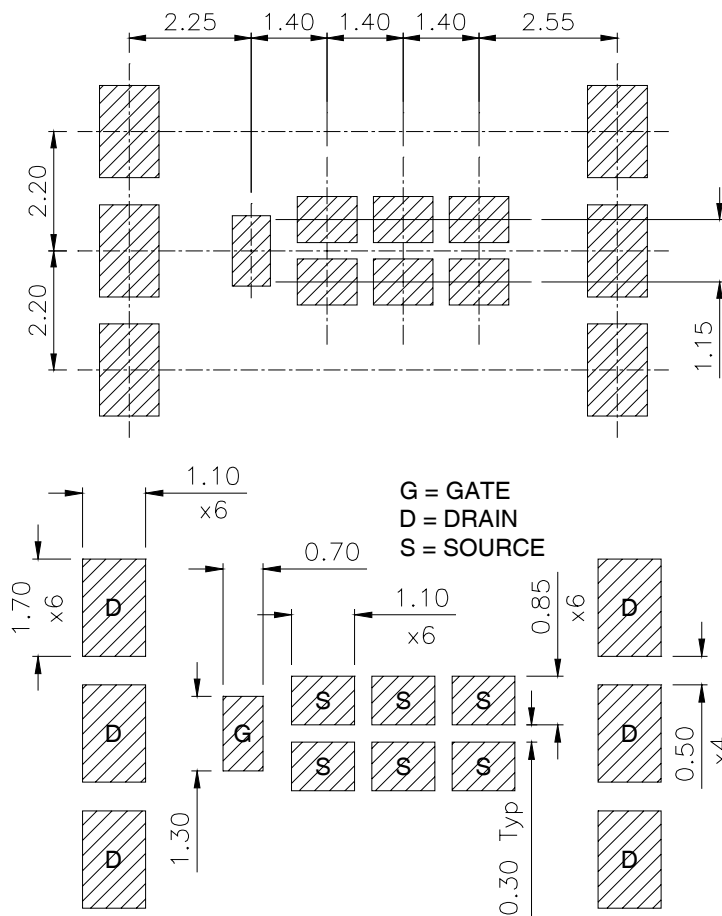

Fig 19. Diode Reverse Recovery Test Circuit for N-Channel HEXFET® Power MOSFETs

DirectFET™ Board Footprint, L6 (Large Size Can).

Please see AN-1035 for DirectFET assembly details and stencil and substrate design recommendations



DirectFET™ Outline Dimension, L6 Outline (LargeSize Can).

Please see AN-1035 for DirectFET assembly details and stencil and substrate design recommendations

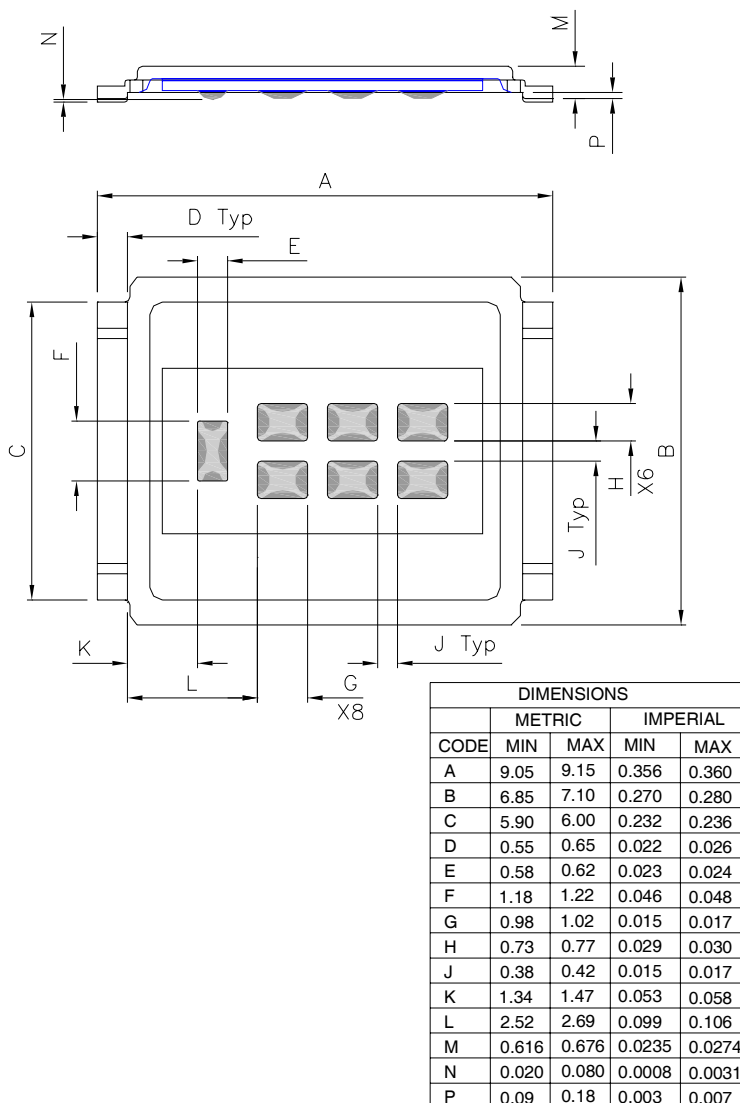

DirectFET™ Part Marking

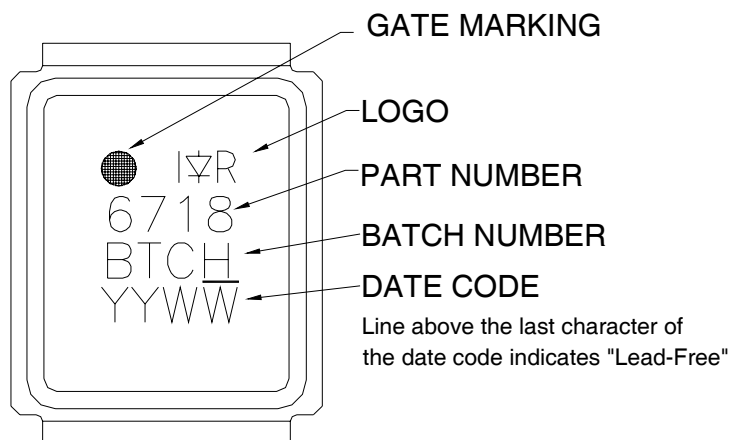

DirectFET™ Tape & Reel Dimension (Showing component orientation).

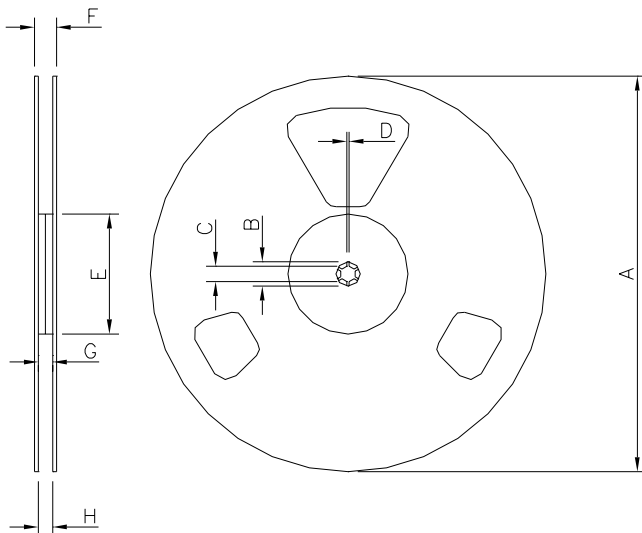

NOTE: Controlling dimensions in mm Std reel quantity is 4000 parts. (ordered as IRF6718L2PBF).

REEL DIMENSIONS				
STANDARD OPTION (QTY 4000)				
	METRIC		IMPERIAL	
CODE	MIN	MAX	MIN	MAX
A	330.0	N.C	12.992	N.C
B	20.2	N.C	0.795	N.C
C	12.8	13.2	0.504	0.520
D	1.5	N.C	0.059	N.C
E	100.0	N.C	3.937	N.C
F	N.C	22.4	N.C	0.889
G	16.4	18.4	0.646	0.724
H	15.9	18.4	0.626	0.724

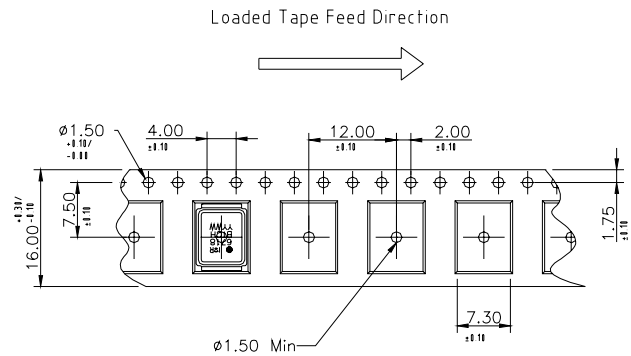

NOTE: CONTROLLING DIMENSIONS IN MM

CODE	DIMENSIONS			
	METRIC		IMPERIAL	
	MIN	MAX	MIN	MAX
A	11.90	12.10	0.469	0.476
B	4.00	N/C	0.157	N/C
C	15.90	16.30	0.623	0.642
D	7.40	7.60	0.291	0.299
E	7.20	7.40	0.283	0.291
F	9.30	9.50	0.366	0.374
G	1.50	N/C	0.059	N/C
H	1.50	1.60	0.059	0.063

Note: For the most current drawing please refer to IR website at <http://www.irf.com/package>

Data and specifications subject to change without notice.

This product has been designed and qualified to MSL1 rating for the Consumer market.

Additional storage requirement details for DirectFET products can be found in application note AN1035 on IR's Web site.

Qualification Standards can be found on IR's Web site.

International
IR Rectifier

IR WORLD HEADQUARTERS: 233 Kansas St., El Segundo, California 90245, USA Tel: (310) 252-7105

TAC Fax: (310) 252-7903

Visit us at www.irf.com for sales contact information.01/2010