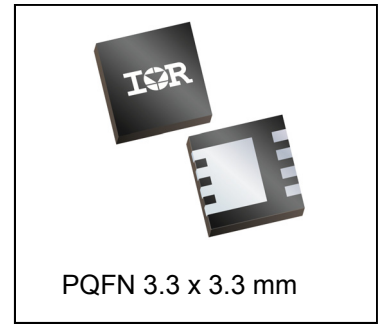
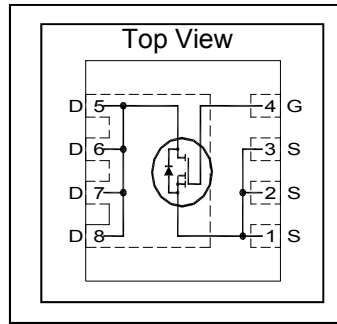


HEXFET® Power MOSFET

V_{DSS}	25	V
R_{DS(on)} max (@ V _{GS} = 10V)	2.2	mΩ
(@ V _{GS} = 4.5V)	3.3	
Qg (typical)	16	nC
I_D (@T _{C (Bottom)} = 25°C)	40 Ⓢ	A



Applications

- Control or Synchronous MOSFET for high frequency buck converters

Features

Low R _{DS(on)} (<2.2mΩ)
Low Charge (typical 16nC)
Low Thermal Resistance to PCB (<3.2°C/W)
Low Profile (<0.9 mm)
Industry-Standard Pinout
Compatible with Existing Surface Mount Techniques
RoHS Compliant, Halogen-Free
MSL1

results in

⇒

Benefits

Lower Conduction Losses
Low Switching Losses
Enable better thermal dissipation
Increased Power Density
Multi-Vendor Compatibility
Easier Manufacturing
Environmentally Friendlier
Increased Reliability

Base part number	Package Type	Standard Pack		Orderable Part Number
		Form	Quantity	
IRFHM4226TRPbF	PQFN 3.3mm x 3.3mm	Tape and Reel	4000	IRFHM4226TRPbF

Absolute Maximum Ratings

	Parameter	Max.	Units
V _{GS}	Gate-to-Source Voltage	± 20	V
I _D @ T _A = 25°C	Continuous Drain Current, V _{GS} @ 10V	28	A
I _D @ T _{C(Bottom)} = 25°C	Continuous Drain Current, V _{GS} @ 10V	105Ⓢ ⑦	
I _D @ T _{C(Bottom)} = 100°C	Continuous Drain Current, V _{GS} @ 10V	67Ⓢ ⑦	
I _D @ T _C = 25°C	Continuous Drain Current, V _{GS} @ 10V (Source Bonding Technology Limited)	40⑦	
I _{DM}	Pulsed Drain Current ①	420Ⓢ	
P _D @ T _A = 25°C	Power Dissipation ⑤	2.7	W
P _D @ T _{C(Bottom)} = 25°C	Power Dissipation ⑤	39	
	Linear Derating Factor ⑤	0.021	W/°C
T _J T _{STG}	Operating Junction and Storage Temperature Range	-55 to + 150	°C

Notes ① through ⑧ are on page 8

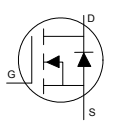
Static @ T_J = 25°C (unless otherwise specified)

	Parameter	Min.	Typ.	Max.	Units	Conditions
BV _{DSS}	Drain-to-Source Breakdown Voltage	25	—	—	V	V _{GS} = 0V, I _D = 250μA
ΔBV _{DSS} /ΔT _J	Breakdown Voltage Temp. Coefficient	—	21	—	mV/°C	Reference to 25°C, I _D = 1mA
R _{DS(on)}	Static Drain-to-Source On-Resistance	—	1.7	2.2	mΩ	V _{GS} = 10V, I _D = 30A ③
		—	2.6	3.3		V _{GS} = 4.5V, I _D = 30A ③
V _{GS(th)}	Gate Threshold Voltage	1.1	1.6	2.1	V	V _{DS} = V _{GS} , I _D = 50μA
ΔV _{GS(th)}	Gate Threshold Voltage Coefficient	—	-5.7	—	mV/°C	
I _{DSS}	Drain-to-Source Leakage Current	—	—	1.0	μA	V _{DS} = 20V, V _{GS} = 0V
I _{GSS}	Gate-to-Source Forward Leakage	—	—	100	nA	V _{GS} = 20V
	Gate-to-Source Reverse Leakage	—	—	-100		V _{GS} = -20V
g _{fs}	Forward Transconductance	136	—	—	S	V _{DS} = 10V, I _D = 30A
Q _g	Total Gate Charge	—	32	—	nC	V _{GS} = 10V, V _{DS} = 13V, I _D = 30A
Q _g	Total Gate Charge	—	16	24	nC	V _{DS} = 13V V _{GS} = 4.5V I _D = 30A
Q _{gs1}	Pre-V _{th} Gate-to-Source Charge	—	3.6	—		
Q _{gs2}	Post-V _{th} Gate-to-Source Charge	—	2.0	—		
Q _{gd}	Gate-to-Drain Charge	—	5.8	—		
Q _{godr}	Gate Charge Overdrive	—	4.6	—		
Q _{sw}	Switch Charge (Q _{gs2} + Q _{gd})	—	7.8	—		
Q _{oss}	Output Charge	—	15	—	nC	V _{DS} = 16V, V _{GS} = 0V
R _G	Gate Resistance	—	1.1	—	Ω	
t _{d(on)}	Turn-On Delay Time	—	11	—	ns	V _{DD} = 13V, V _{GS} = 4.5V I _D = 30A R _G = 1.8Ω
t _r	Rise Time	—	35	—		
t _{d(off)}	Turn-Off Delay Time	—	14	—		
t _f	Fall Time	—	8.1	—		
C _{iss}	Input Capacitance	—	2000	—	pF	V _{GS} = 0V V _{DS} = 13V f = 1.0MHz
C _{oss}	Output Capacitance	—	570	—		
C _{rss}	Reverse Transfer Capacitance	—	150	—		

Avalanche Characteristics

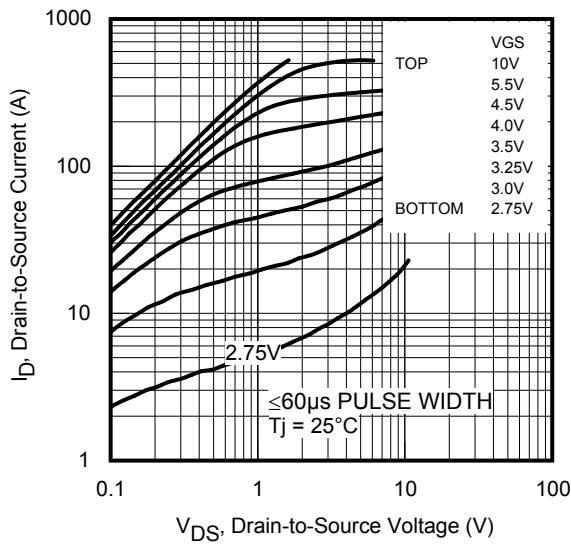
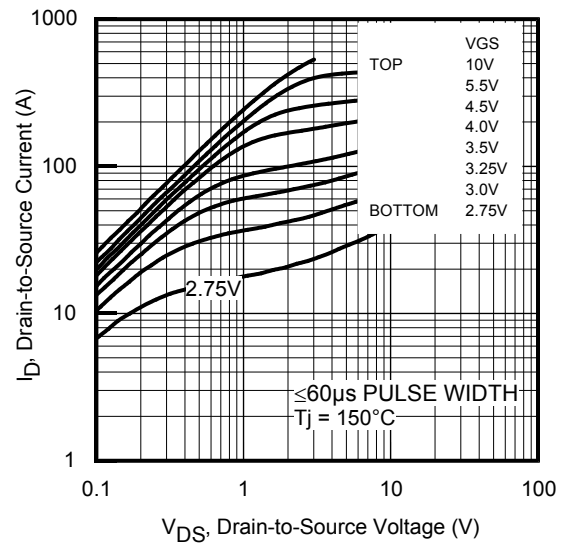
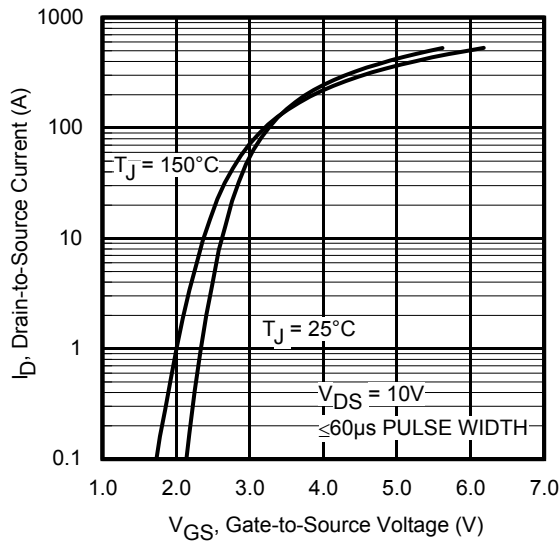
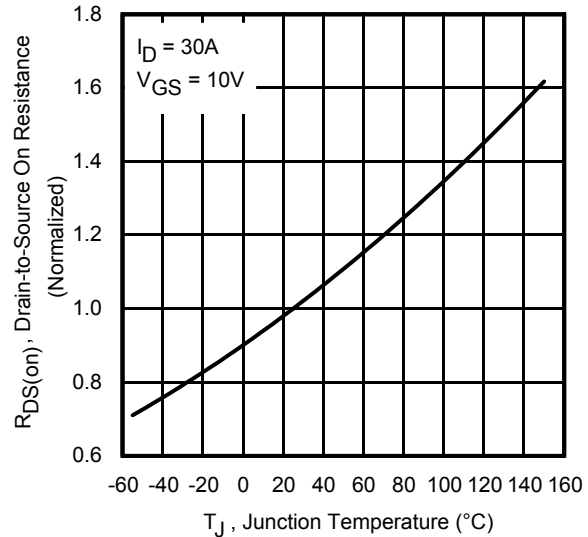
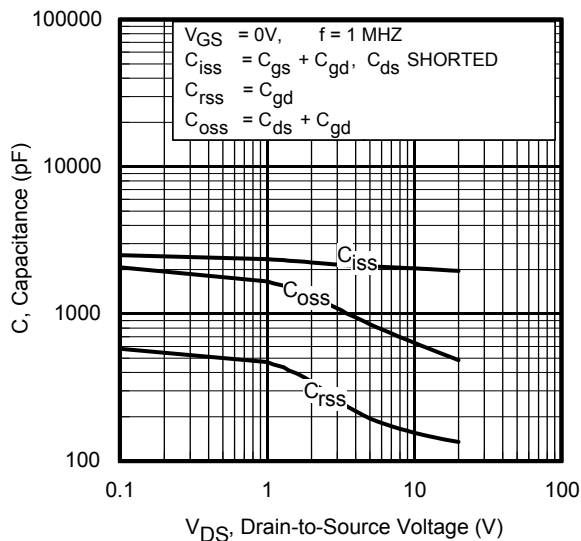
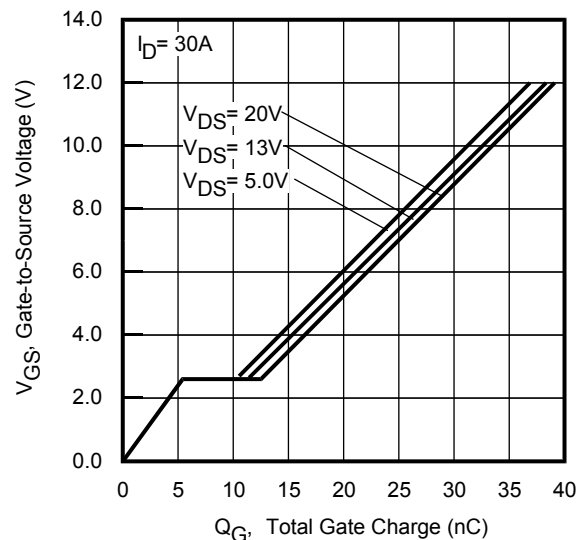
	Parameter	Typ.	Max.	Units
E _{AS}	Single Pulse Avalanche Energy ②	—	124	mJ
I _{AR}	Avalanche Current ①	—	30	A

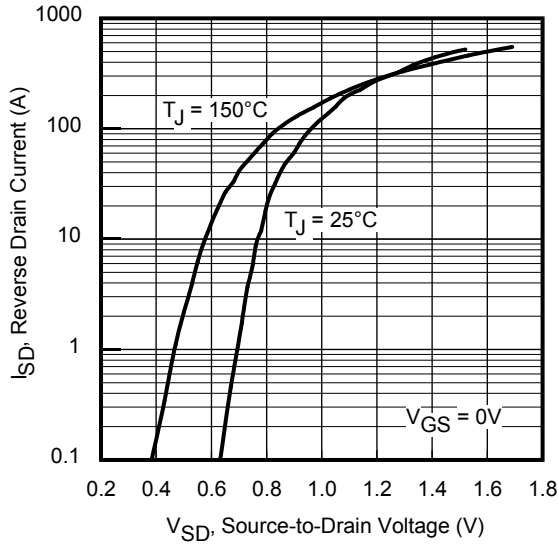
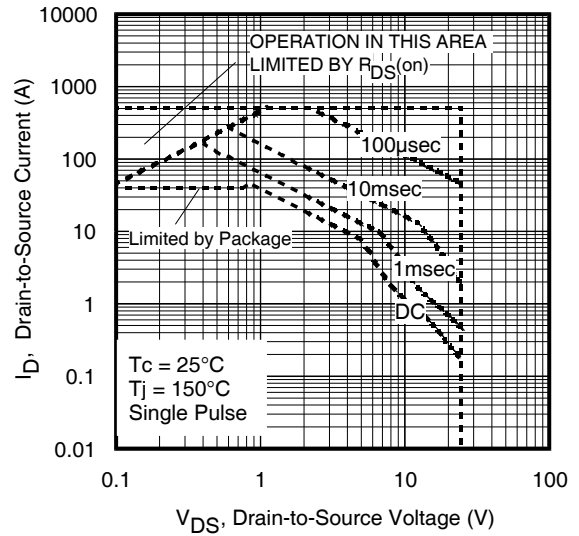
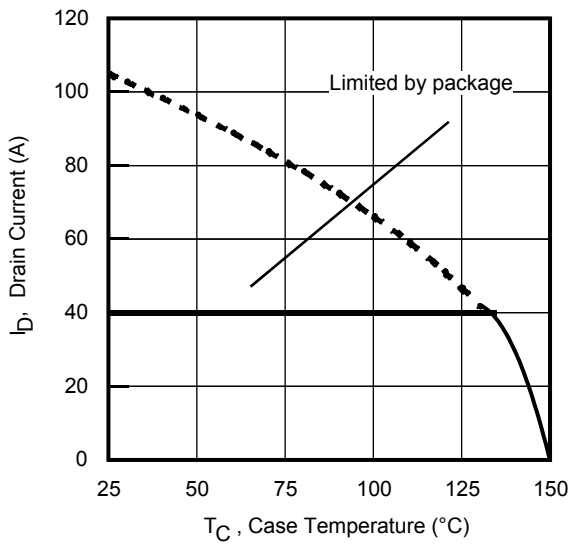
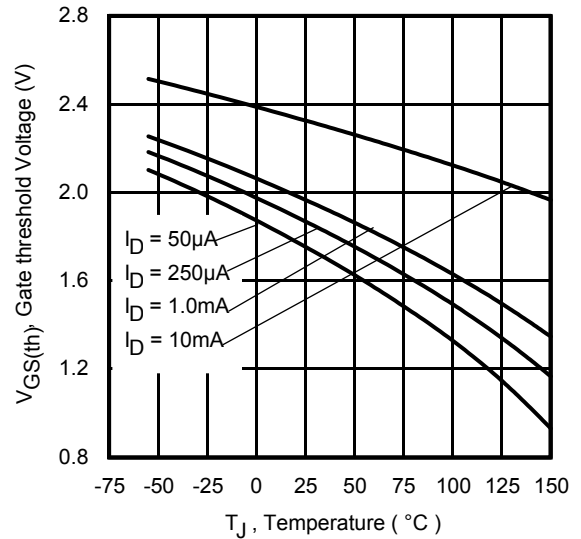
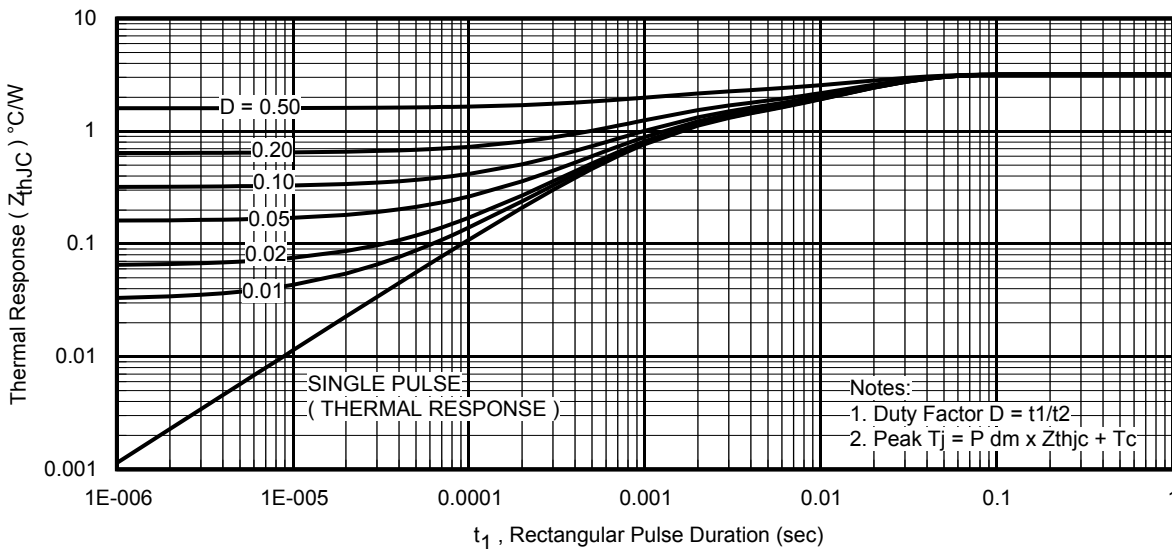
Diode Characteristics

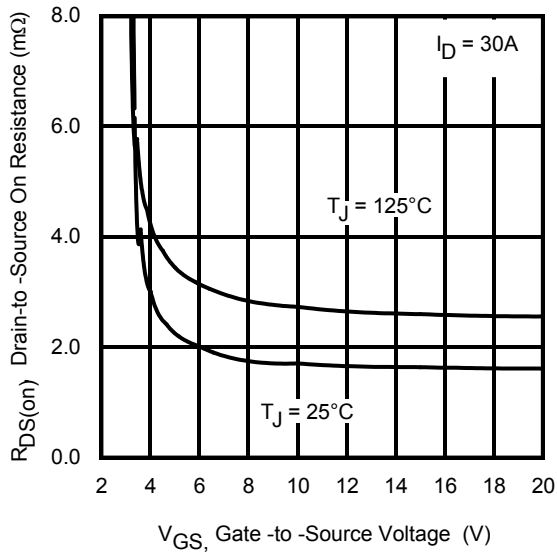
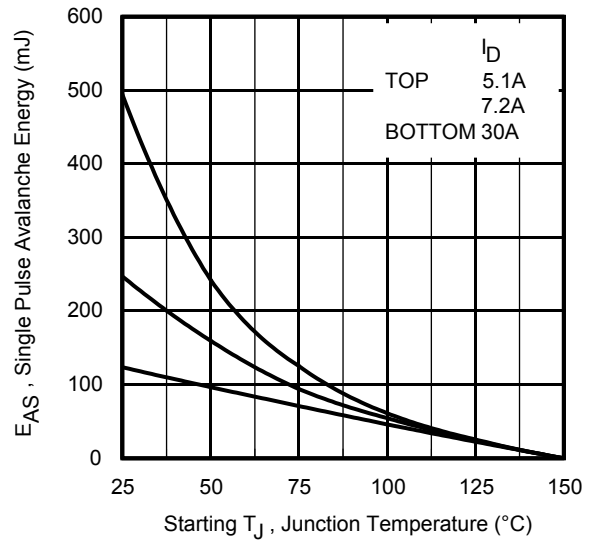
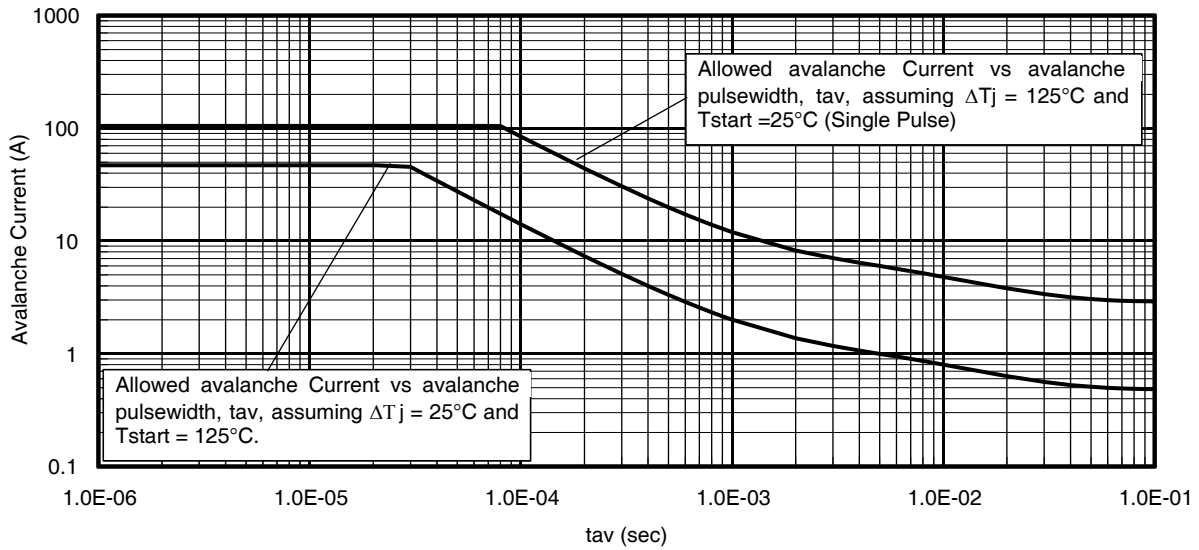
	Parameter	Min.	Typ.	Max.	Units	Conditions
I _S	Continuous Source Current (Body Diode)	—	—	40⑥	A	MOSFET symbol showing the integral reverse p-n junction diode. 
I _{SM}	Pulsed Source Current (Body Diode) ①	—	—	500⑧		
V _{SD}	Diode Forward Voltage	—	—	1.0	V	T _J = 25°C, I _S = 30A, V _{GS} = 0V ③
t _{rr}	Reverse Recovery Time	—	16	24	ns	T _J = 25°C, I _F = 30A, V _{DD} = 13V
Q _{rr}	Reverse Recovery Charge	—	28	42	nC	di/dt = 450A/μs ③

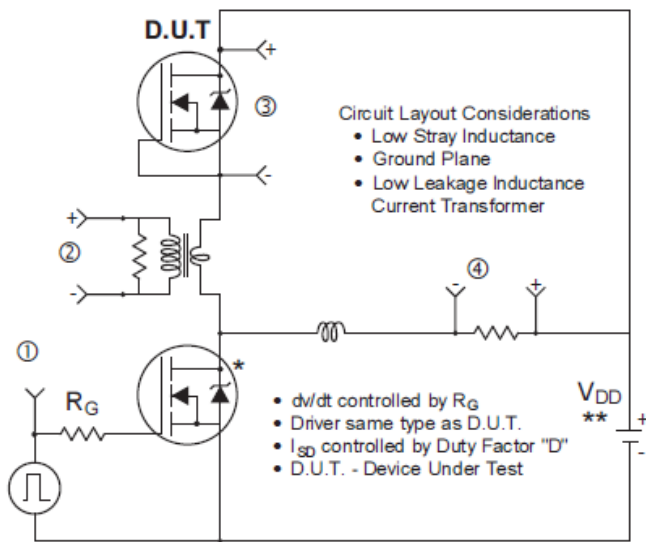
Thermal Resistance

	Parameter	Typ.	Max.	Units
R _{θJC} (Bottom)	Junction-to-Case ④	—	3.2	°C/W
R _{θJC} (Top)	Junction-to-Case ④	—	35	
R _{θJA}	Junction-to-Ambient ⑤	—	47	
R _{θJA} (<10s)	Junction-to-Ambient ⑤	—	30	

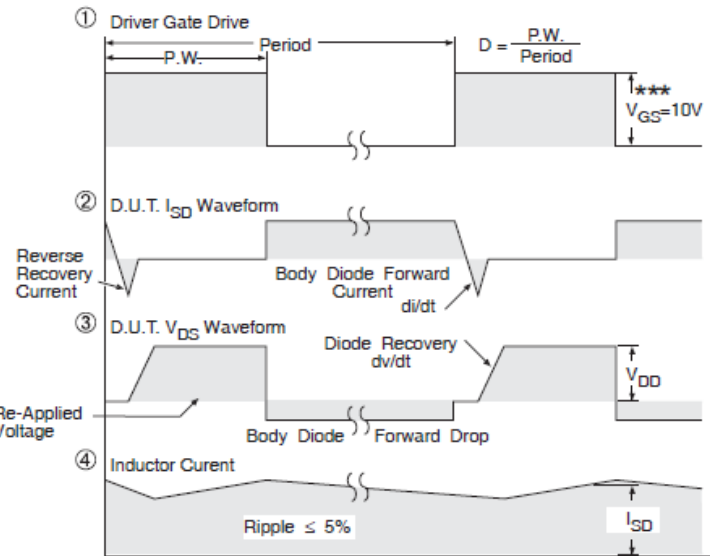

Fig 1. Typical Output Characteristics

Fig 2. Typical Output Characteristics

Fig 3. Typical Transfer Characteristics

Fig 4. Normalized On-Resistance vs. Temperature

Fig 5. Typical Capacitance vs. Drain-to-Source Voltage

Fig 6. Typical Gate Charge vs. Gate-to-Source Voltage


Fig 7. Typical Source-Drain Diode Forward Voltage

Fig 8. Maximum Safe Operating Area

Fig 9. Maximum Drain Current vs. Case Temperature

Fig 10. Threshold Voltage Vs. Temperature

Fig 11. Maximum Effective Transient Thermal Impedance, Junction-to-Case

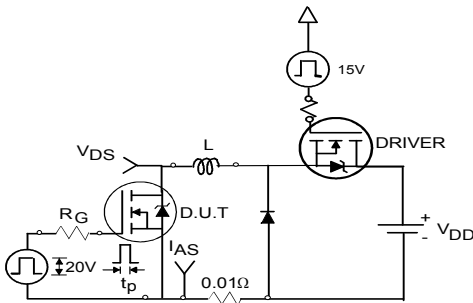
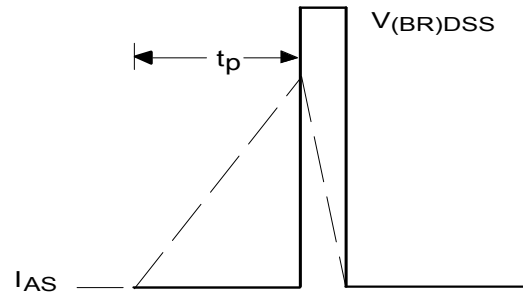
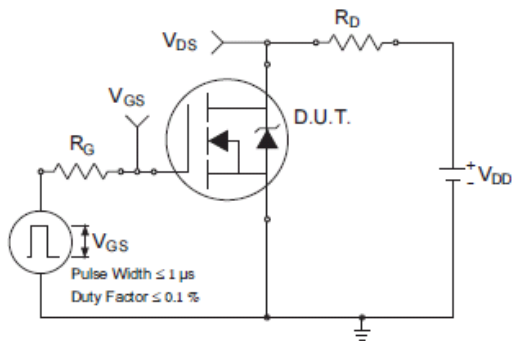
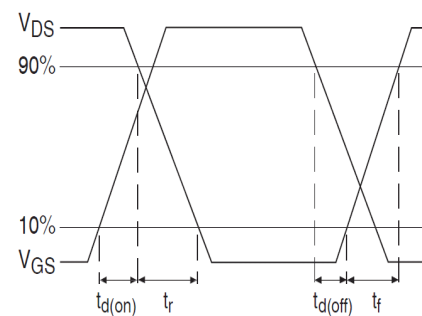
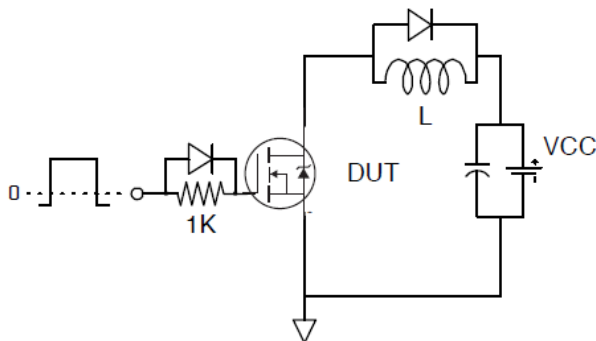
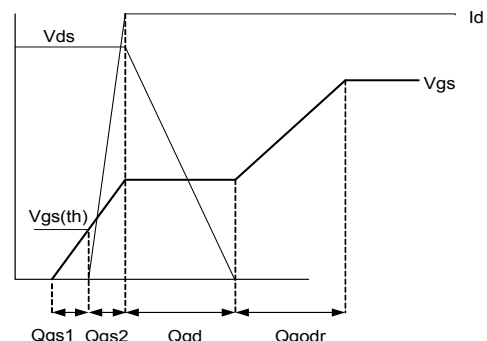

Fig 12. On-Resistance vs. Gate Voltage

Fig 13. Maximum Avalanche Energy vs. Drain Current

Fig 14. Typical Avalanche Current vs. Pulsewidth

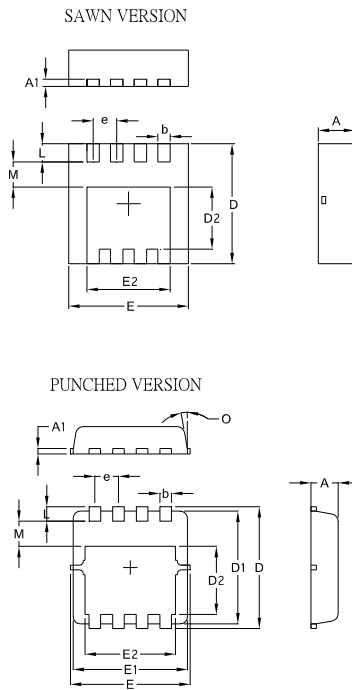


* Use P-Channel Driver for P-Channel Measurements
 ** Reverse Polarity for P-Channel

Fig 15. Peak Diode Recovery dv/dt Test Circuit for N-Channel HEXFET® Power MOSFETs


*** $V_{GS} = 5V$ for Logic Level Devices

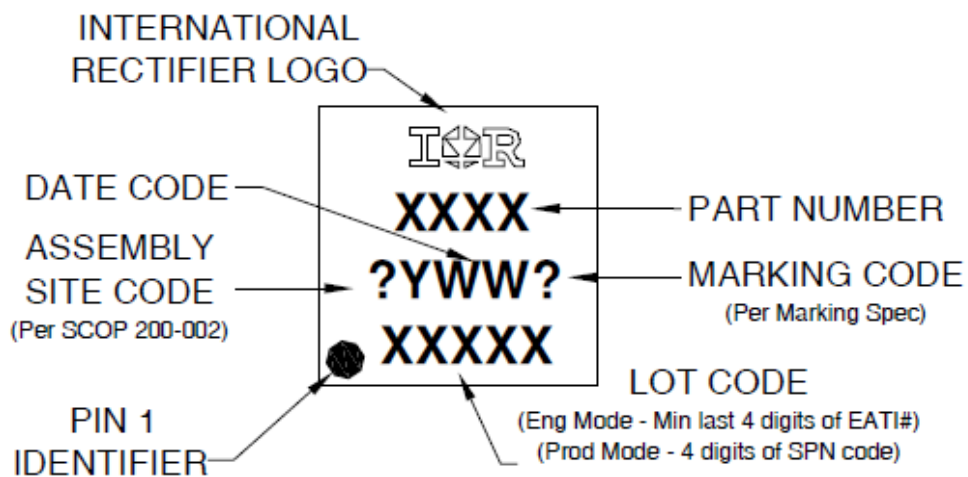

Fig 16a. Unclamped Inductive Test Circuit

Fig 16b. Unclamped Inductive Waveforms

Fig 17a. Switching Time Test Circuit

Fig 17b. Switching Time Waveforms

Fig 18. Gate Charge Test Circuit

Fig 19. Gate Charge Waveform

PQFN 3.3 x 3.3 Package Details


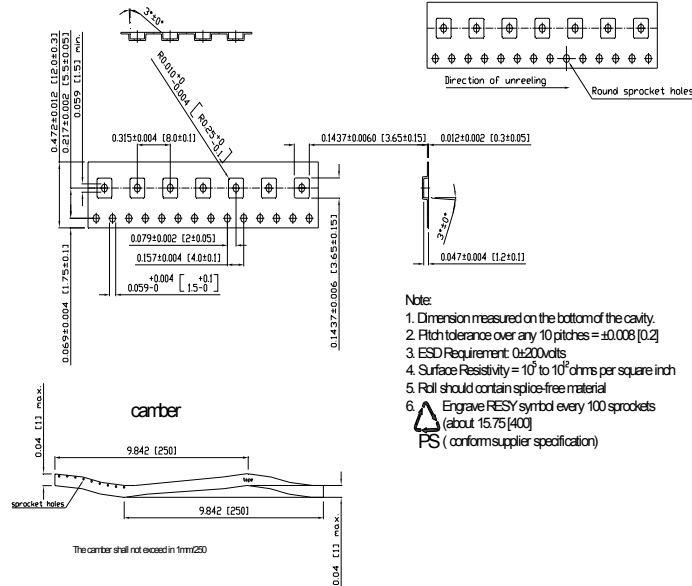
SYMBOL	COMMON			
	MM		INCH	
	MIN.	MAX.	MIN.	MAX.
A	0.70	1.05	0.0276	0.0413
A1	0.12	0.39	0.0047	0.0154
b	0.25	0.39	0.0098	0.0154
D	3.20	3.45	0.1260	0.1358
D1	3.00	3.20	0.1181	0.1417
D2	1.69	2.20	0.0665	0.0866
E	3.20	3.40	0.1260	0.1339
E1	3.00	3.20	0.1181	0.1417
E2	2.15	2.59	0.0846	0.1020
e	0.65 BSC		0.0256 BSC	
L	0.15	0.55	0.0059	0.0217
M	0.59	—	0.0232	—
O	9Deg	12Deg	9Deg	12Deg

For more information on board mounting, including footprint and stencil recommendation, please refer to application note AN-1136: <http://www.irf.com/technical-info/appnotes/an-1136.pdf>

For more information on package inspection techniques, please refer to application note AN-1154: <http://www.irf.com/technical-info/appnotes/an-1154.pdf>

PQFN 3.3 x 3.3 Part Marking


Note: For the most current drawing please refer to IR website at <http://www.irf.com/package/>

PQFN 3.3 x 3.3 Tape and Reel


- Note:
1. Dimension measured on the bottom of the cavity.
 2. Pitch tolerance over any 10 pitches = ±0.008 [0.2]
 3. ESD Requirement: 0±200volts
 4. Surface Resistivity = 10^7 to 10^9 ohms per square inch
 5. Roll should contain splice-free material
 6. Engrave RESY symbol every 100 sprockets (about 15.75 [400])
- PS (conforms supplier specification)

Note: For the most current drawing please refer to IR website at <http://www.irf.com/package/>

Qualification Information†

Moisture Sensitivity Level	PQFN 3.3mm x 3.3mm	MSL1 (per JEDEC J-STD-020D††)
RoHS Compliant	Yes	

† Qualification standards can be found at International Rectifier's web site: <http://www.irf.com/product-info/reliability>

†† Applicable version of JEDEC standard at the time of product release.

Notes:

- ① Repetitive rating; pulse width limited by max. junction temperature.
- ② Starting $T_J = 25^\circ\text{C}$, $L = 0.275\text{mH}$, $R_G = 50\Omega$, $I_{AS} = 30\text{A}$.
- ③ Pulse width $\leq 400\mu\text{s}$; duty cycle $\leq 2\%$.
- ④ R_θ is measured at T_J of approximately 90°C .
- ⑤ When mounted on 1 inch square PCB (FR-4). Please refer to AN-994 for more details: <http://www.irf.com/technical-info/appnotes/an-994.pdf>
- ⑥ Calculated continuous current based on maximum allowable junction temperature.
- ⑦ Current is limited to 40A by source bonding technology.
- ⑧ Pulse drain current is limited by source bonding technology.

Revision History

Date	Comments
08/07/13	• Added "Fast/RFET™" above part number on page1