

# IRG4BC15UDPbF

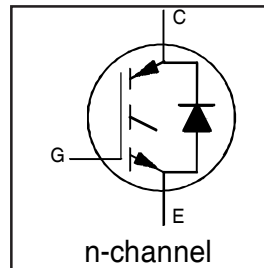
INSULATED GATE BIPOLAR TRANSISTOR WITH ULTRAFAST SOFT RECOVERY DIODE UltraFast CoPack IGBT

## Features

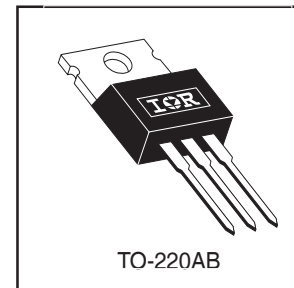
- UltraFast: Optimized for high frequencies from 10 to 30 kHz in hard switching
- IGBT Co-packaged with ultra-soft-recovery antiparallel diode
- Industry standard TO-220AB package
- Lead-Free

## Benefits

- Best Value for Appliance and Industrial Applications
- High noise immune "Positive Only" gate drive- Negative bias gate drive not necessary
- For Low EMI designs- requires little or no snubbing
- Single Package switch for bridge circuit applications
- Compatible with high voltage Gate Driver IC's
- Allows simpler gate drive



$V_{CES} = 600V$
$V_{CE(on)} \text{ typ.} = 2.02V$
@ $V_{GE} = 15V, I_C = 7.8A$



## Absolute Maximum Ratings

	Parameter	Max.	Units
$V_{CES}$	Collector-to-Emitter Voltage	600	V
$I_C @ T_C = 25^\circ C$	Continuous Collector Current	14	A
$I_C @ T_C = 100^\circ C$	Continuous Collector Current	7.8	
$I_{CM}$	Pulsed Collector Current ①	42	
$I_{LM}$	Clamped Inductive Load Current ②	42	
$I_F @ T_C = 100^\circ C$	Diode Continuous Forward Current	4.0	
$I_{FM}$	Diode Maximum Forward Current	16	
$V_{GE}$	Gate-to-Emitter Voltage	$\pm 20$	V
$P_D @ T_C = 25^\circ C$	Maximum Power Dissipation	49	W
$P_D @ T_C = 100^\circ C$	Maximum Power Dissipation	19	
$T_J$	Operating Junction and Storage Temperature Range	-55 to +150	$^\circ C$
$T_{STG}$			
	Mounting Torque, 6-32 or M3 Screw.	10 lbf•in (1.1 N•m)	

## Thermal Resistance

	Parameter	Min.	Typ.	Max.	Units
$R_{\theta JC}$	Junction-to-Case - IGBT	—	—	2.7	$^\circ C/W$
$R_{\theta JC}$	Junction-to-Case - Diode	—	—	7.0	
$R_{\theta CS}$	Case-to-Sink, flat, greased surface	—	0.50	—	
$R_{\theta JA}$	Junction-to-Ambient, typical socket mount	—	—	80	
Wt	Weight	—	2 (0.07)	—	g (oz)

# IRG4BC15UDPbF

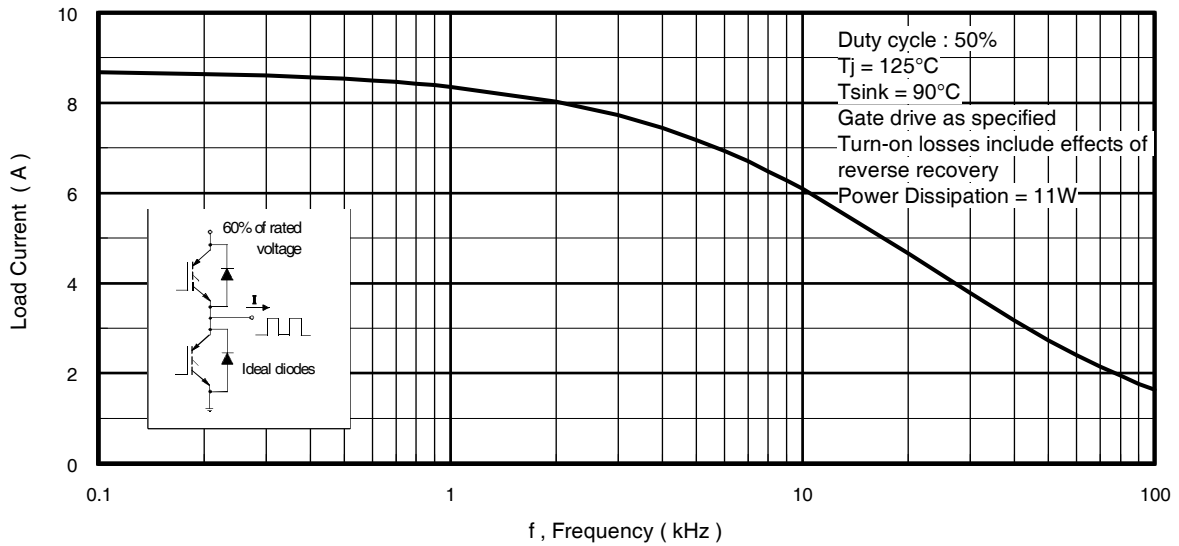
International  
 Rectifier

## Electrical Characteristics @ T<sub>J</sub> = 25°C (unless otherwise specified)

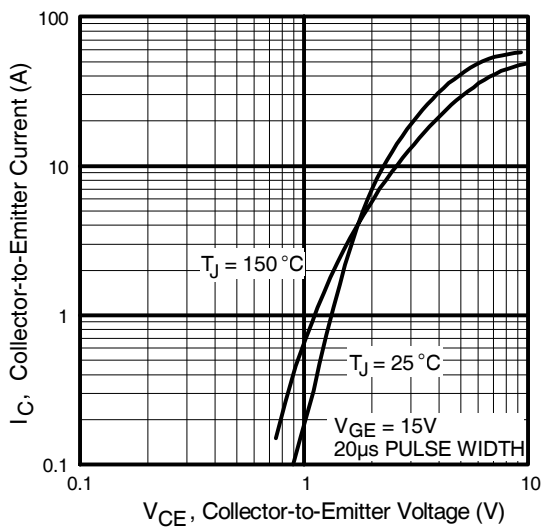
	Parameter	Min.	Typ.	Max.	Units	Conditions
V <sub>(BR)CES</sub>	Collector-to-Emitter Breakdown Voltage <sup>③</sup>	600	—	—	V	V <sub>GE</sub> = 0V, I <sub>C</sub> = 250μA
ΔV <sub>(BR)CES</sub> /ΔT <sub>J</sub>	Temperature Coeff. of Breakdown Voltage	—	0.63	—	V/°C	V <sub>GE</sub> = 0V, I <sub>C</sub> = 1.0mA
V <sub>CE(on)</sub>	Collector-to-Emitter Saturation Voltage	—	2.02	2.4	V	I <sub>C</sub> = 7.8A
		—	2.56	—		I <sub>C</sub> = 14A
		—	2.21	—		I <sub>C</sub> = 7.8A, T <sub>J</sub> = 150°C
V <sub>GE(th)</sub>	Gate Threshold Voltage	3.0	—	6.0		V <sub>CE</sub> = V <sub>GE</sub> , I <sub>C</sub> = 250μA
ΔV <sub>GE(th)</sub> /ΔT <sub>J</sub>	Temperature Coeff. of Threshold Voltage	—	-10	—	mV/°C	V <sub>CE</sub> = V <sub>GE</sub> , I <sub>C</sub> = 250μA
g <sub>fe</sub>	Forward Transconductance <sup>④</sup>	4.1	6.2	—	S	V <sub>CE</sub> = 100V, I <sub>C</sub> = 7.8A
I <sub>CES</sub>	Zero Gate Voltage Collector Current	—	—	250	μA	V <sub>GE</sub> = 0V, V <sub>CE</sub> = 600V
		—	—	1400		V <sub>GE</sub> = 0V, V <sub>CE</sub> = 600V, T <sub>J</sub> = 150°C
V <sub>FM</sub>	Diode Forward Voltage Drop	—	1.5	1.8	V	I <sub>C</sub> = 4.0A
		—	1.4	1.7		I <sub>C</sub> = 4.0A, T <sub>J</sub> = 150°C
I <sub>GES</sub>	Gate-to-Emitter Leakage Current	—	—	±100	nA	V <sub>GE</sub> = ±20V

## Switching Characteristics @ T<sub>J</sub> = 25°C (unless otherwise specified)

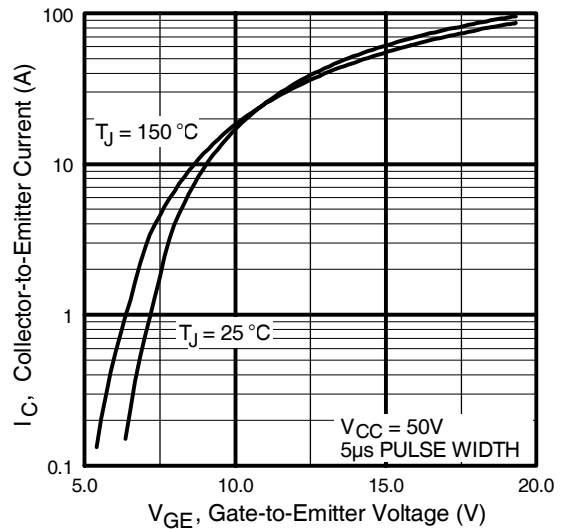
	Parameter	Min.	Typ.	Max.	Units	Conditions	
Q <sub>g</sub>	Total Gate Charge (turn-on)	—	23	35	nC	I <sub>C</sub> = 7.8A	
Q <sub>ge</sub>	Gate - Emitter Charge (turn-on)	—	4.0	6.0		V <sub>CC</sub> = 400V	
Q <sub>gc</sub>	Gate - Collector Charge (turn-on)	—	9.6	14		V <sub>GE</sub> = 15V	
t <sub>d(on)</sub>	Turn-On Delay Time	—	17	—	ns	T <sub>J</sub> = 25°C	
t <sub>r</sub>	Rise Time	—	20	—		I <sub>C</sub> = 7.8A, V <sub>CC</sub> = 480V	
t <sub>d(off)</sub>	Turn-Off Delay Time	—	160	240		V <sub>GE</sub> = 15V, R <sub>G</sub> = 75Ω	
t <sub>f</sub>	Fall Time	—	83	120		Energy losses include "tail" and diode reverse recovery.	
E <sub>on</sub>	Turn-On Switching Loss	—	0.24	—		mJ	
E <sub>off</sub>	Turn-Off Switching Loss	—	0.26	—			
E <sub>ts</sub>	Total Switching Loss	—	0.50	0.63			
t <sub>d(on)</sub>	Turn-On Delay Time	—	16	—	ns	T <sub>J</sub> = 150°C,	
t <sub>r</sub>	Rise Time	—	21	—		I <sub>C</sub> = 7.8A, V <sub>CC</sub> = 480V	
t <sub>d(off)</sub>	Turn-Off Delay Time	—	180	—		V <sub>GE</sub> = 15V, R <sub>G</sub> = 75Ω	
t <sub>f</sub>	Fall Time	—	220	—		Energy losses include "tail" and diode reverse recovery.	
E <sub>ts</sub>	Total Switching Loss	—	0.76	—	mJ		
L <sub>E</sub>	Internal Emitter Inductance	—	7.5	—	nH	Measured 5mm from package	
C <sub>ies</sub>	Input Capacitance	—	410	—	pF	V <sub>GE</sub> = 0V	
C <sub>oes</sub>	Output Capacitance	—	37	—		V <sub>CC</sub> = 30V	
C <sub>res</sub>	Reverse Transfer Capacitance	—	5.3	—		f = 1.0MHz	
t <sub>rr</sub>	Diode Reverse Recovery Time	—	28	42	ns	T <sub>J</sub> = 25°C	
		—	38	57		T <sub>J</sub> = 125°C	
r <sub>r</sub>	Diode Peak Reverse Recovery Current	—	2.9	5.2	A	T <sub>J</sub> = 25°C	
		—	3.7	6.7		T <sub>J</sub> = 125°C	
Q <sub>rr</sub>	Diode Reverse Recovery Charge	—	40	60	nC	T <sub>J</sub> = 25°C	
		—	70	110		T <sub>J</sub> = 125°C	
di <sub>(rec)</sub> M/dt	Diode Peak Rate of Fall of Recovery During t <sub>b</sub>	—	280	—	A/μs	T <sub>J</sub> = 25°C	
		—	240	—		T <sub>J</sub> = 125°C	



**Fig. 1 - Typical Load Current vs. Frequency**  
 (Load Current =  $I_{\text{RMS}}$  of fundamental)

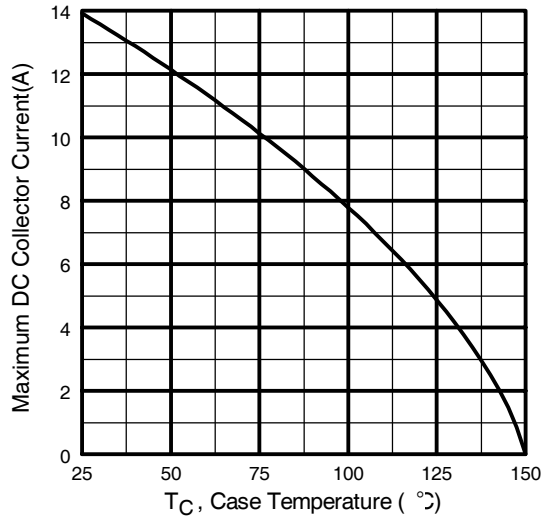


**Fig. 2 - Typical Output Characteristics**

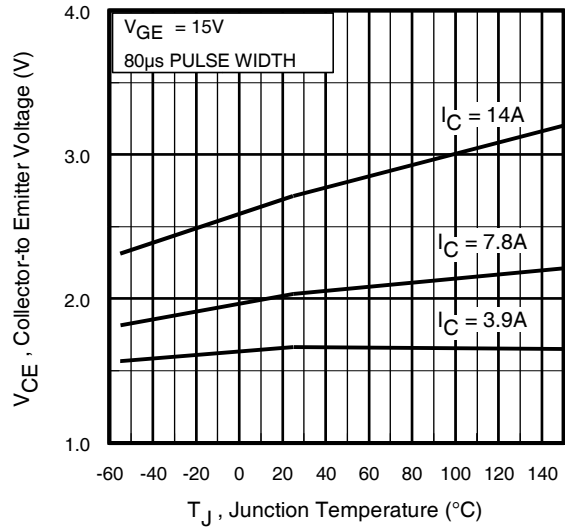


**Fig. 3 - Typical Transfer Characteristics**

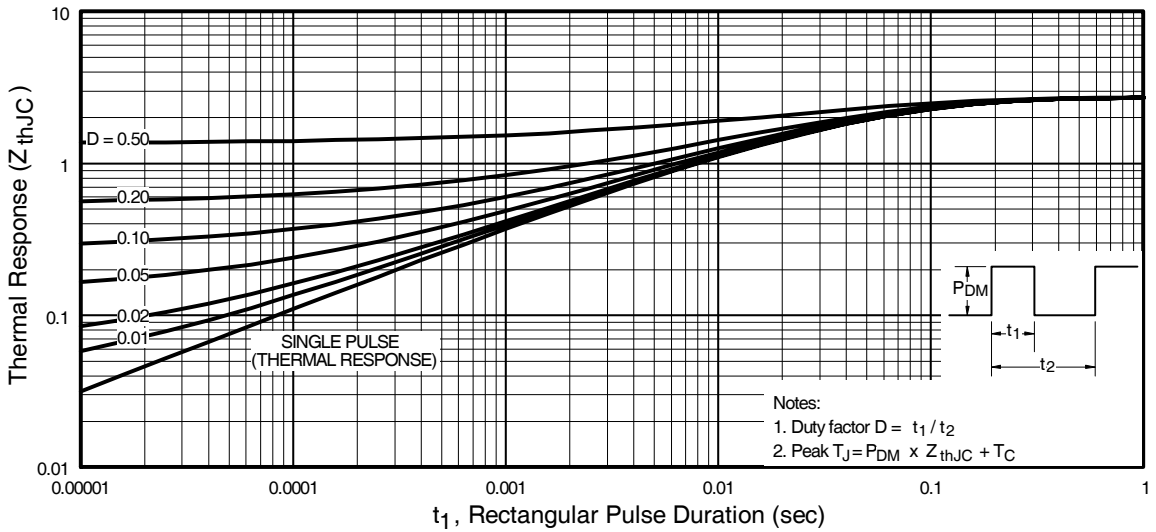
# IRG4BC15UDPbF



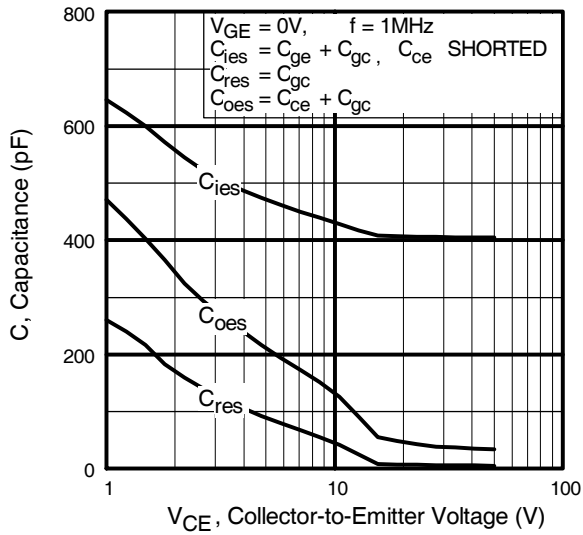
**Fig. 4** - Maximum Collector Current vs. Case Temperature



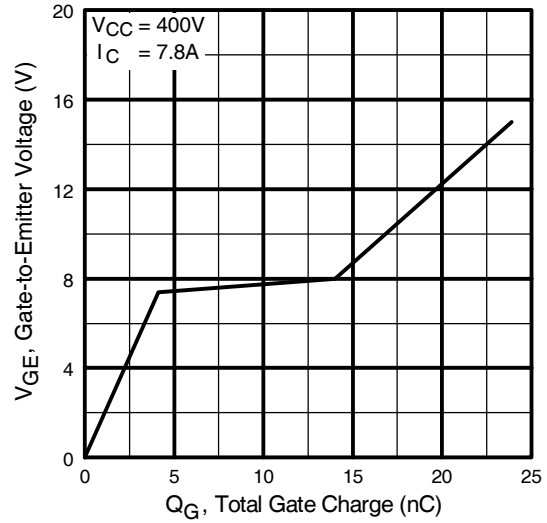
**Fig. 5** - Typical Collector-to-Emitter Voltage vs. Junction Temperature



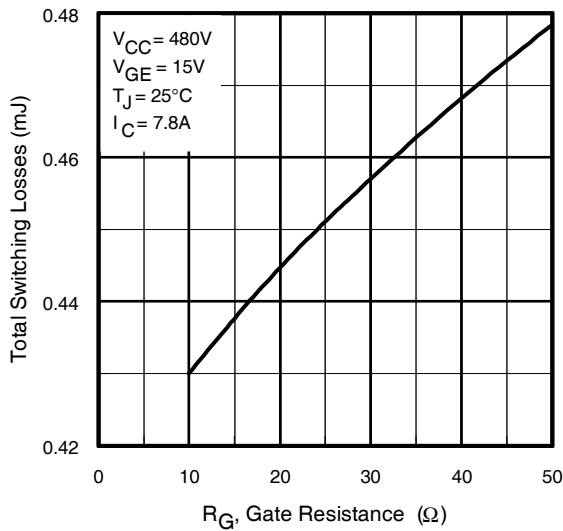
**Fig. 6** - Maximum Effective Transient Thermal Impedance, Junction-to-Case



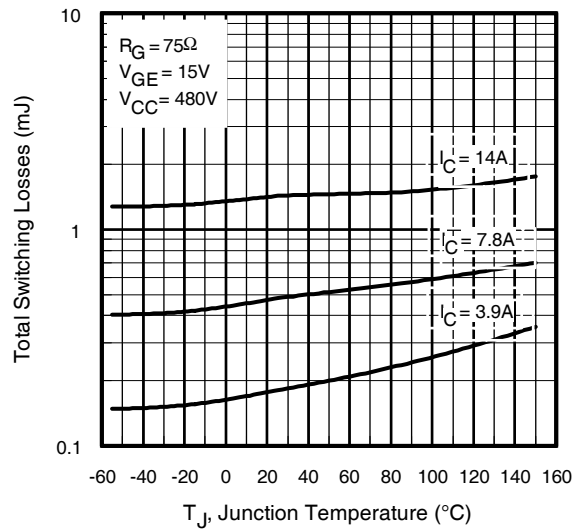
**Fig. 7** - Typical Capacitance vs. Collector-to-Emitter Voltage



**Fig. 8** - Typical Gate Charge vs. Gate-to-Emitter Voltage

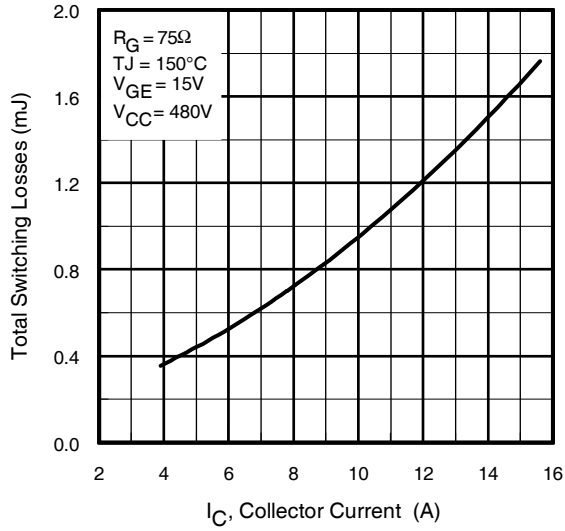


**Fig. 9** - Typical Switching Losses vs. Gate Resistance

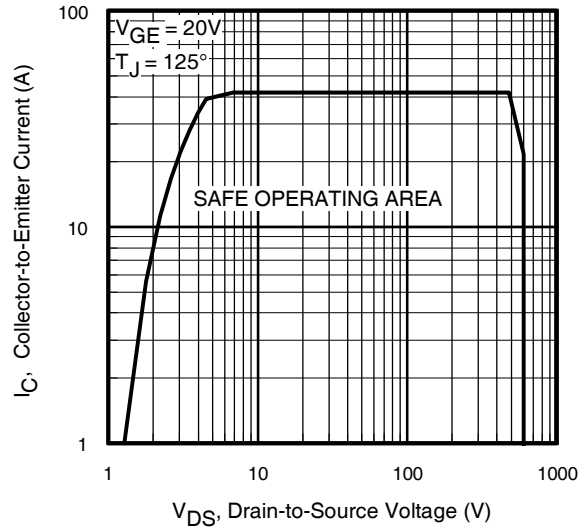


**Fig. 10** - Typical Switching Losses vs. Junction Temperature

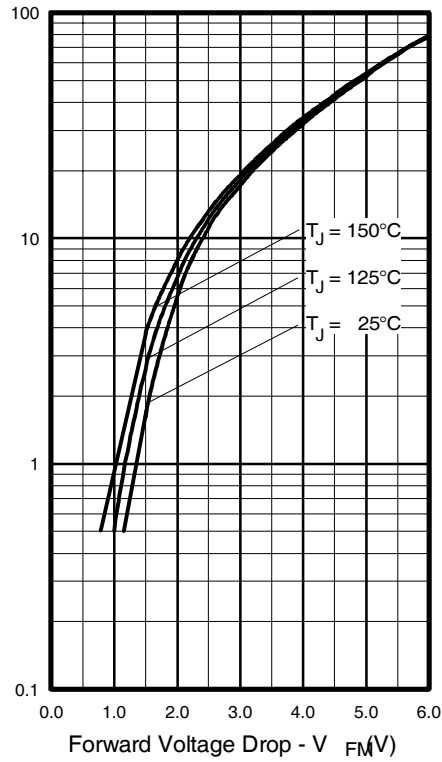
# IRG4BC15UDPbF



**Fig. 11** - Typical Switching Losses vs. Collector-to-Emitter Current



**Fig. 12** - Turn-Off SOA



**Fig. 13** - Maximum Forward Voltage Drop vs. Instantaneous Forward Current

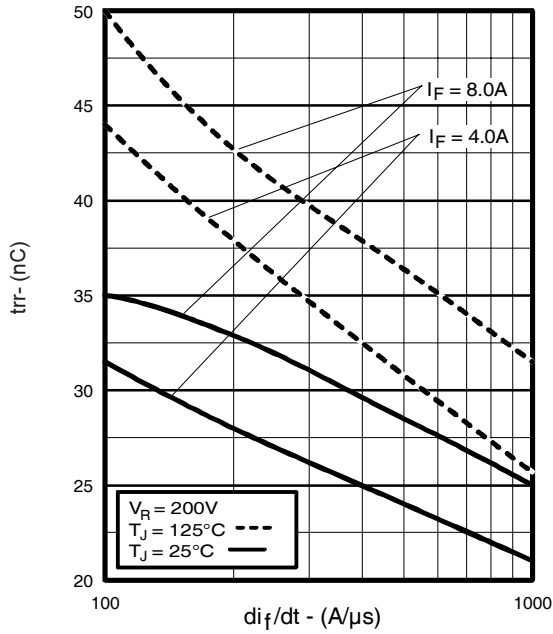


Fig. 14 - Typical Reverse Recovery vs.  $di_f/dt$

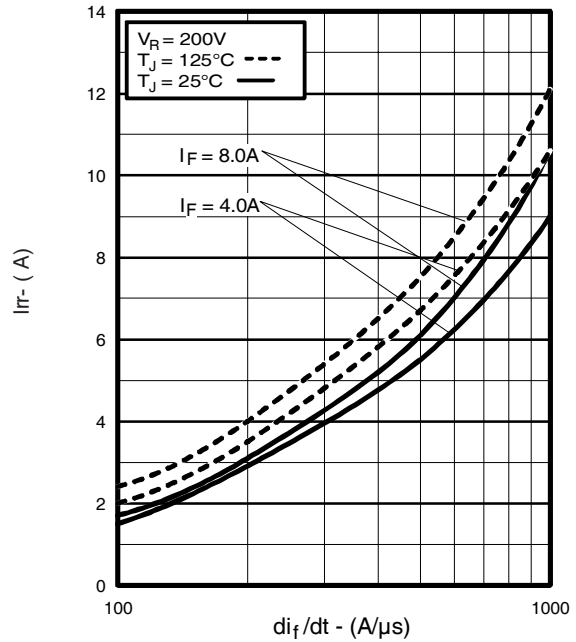


Fig. 15 - Typical Recovery Current vs.  $di_f/dt$

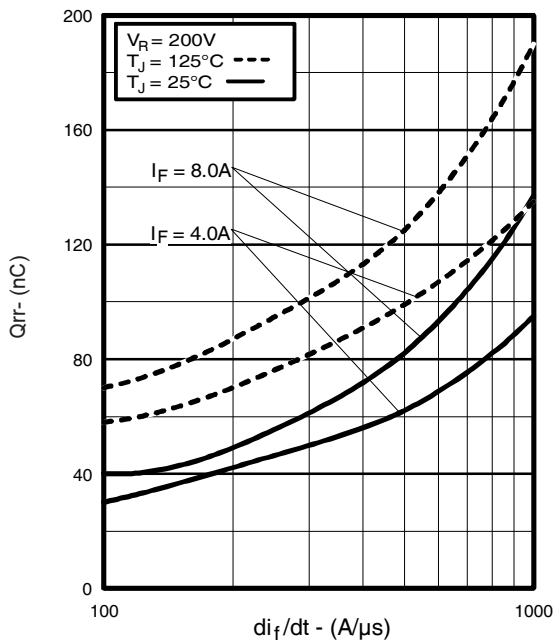


Fig. 16 - Typical Stored Charge vs.  $di_f/dt$

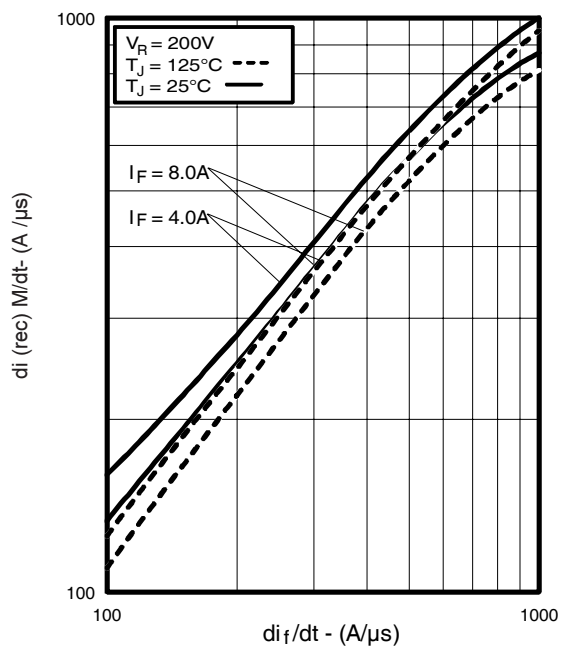
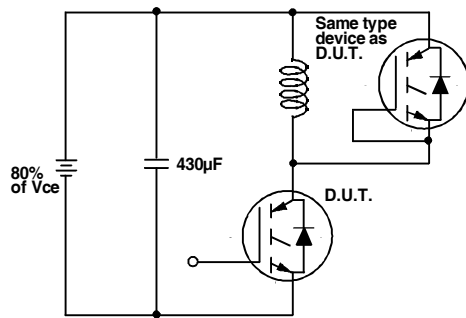


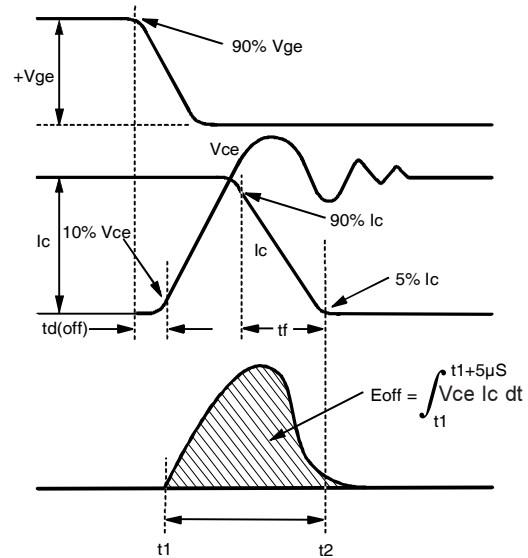
Fig. 17 - Typical  $di_{(rec)M}/dt$  vs.  $di_f/dt$ ,

# IRG4BC15UDPbF

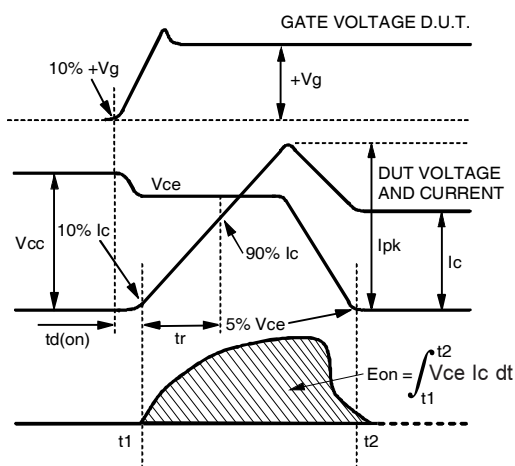
International  
**IR** Rectifier



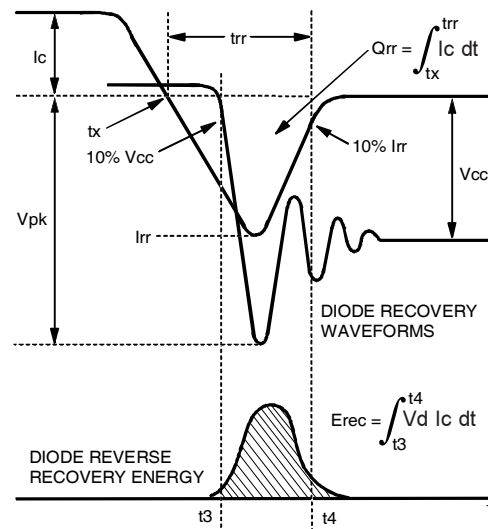
**Fig. 18a** - Test Circuit for Measurement of  $I_{LM}$ ,  $E_{on}$ ,  $E_{off}(\text{diode})$ ,  $t_{rr}$ ,  $Q_{rr}$ ,  $I_{rr}$ ,  $t_{d(on)}$ ,  $t_r$ ,  $t_{d(off)}$ ,  $t_f$



**Fig. 18b** - Test Waveforms for Circuit of Fig. 18a, Defining  $E_{off}$ ,  $t_{d(off)}$ ,  $t_f$



**Fig. 18c** - Test Waveforms for Circuit of Fig. 18a, Defining  $E_{on}$ ,  $t_{d(on)}$ ,  $t_r$



**Fig. 18d** - Test Waveforms for Circuit of Fig. 18a, Defining  $E_{rec}$ ,  $t_{rr}$ ,  $Q_{rr}$ ,  $I_{rr}$



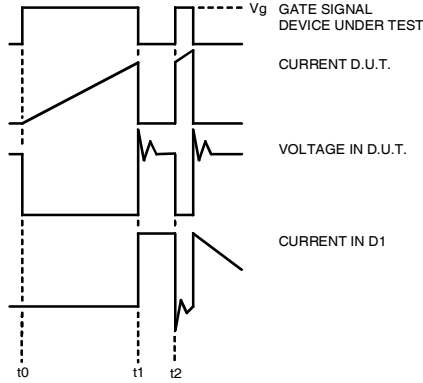


Figure 18e. Macro Waveforms for Figure 18a's Test Circuit

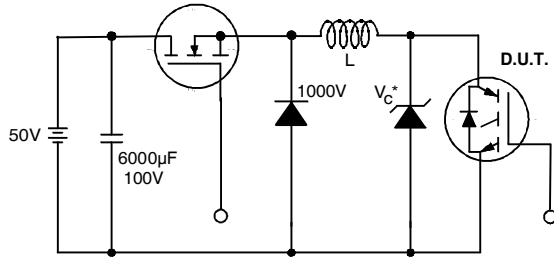


Figure 19. Clamped Inductive Load Test Circuit

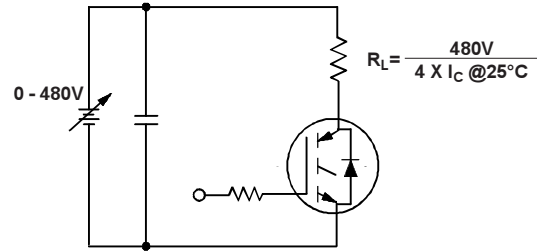


Figure 20. Pulsed Collector Current Test Circuit

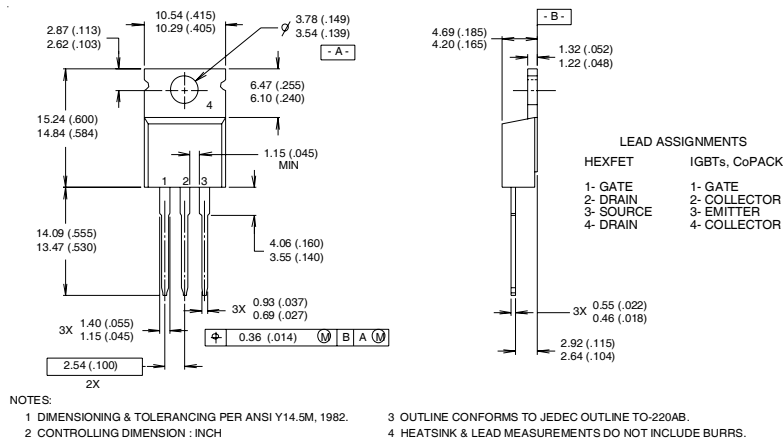
# IRG4BC15UDPbF



## Notes:

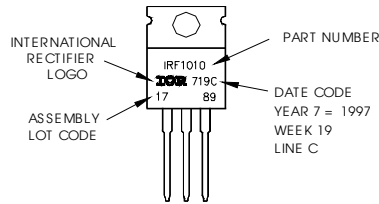
- ① Repetitive rating:  $V_{GE}=20V$ ; pulse width limited by maximum junction temperature
- ②  $V_{CC}=80\%(V_{CES})$ ,  $V_{GE}=20V$ ,  $L=10\mu H$ ,  $R_G = 75\Omega$
- ③ Pulse width  $\leq 80\mu s$ ; duty factor  $\leq 0.1\%$ .
- ④ Pulse width  $5.0\mu s$ , single shot.

## TO-220AB Package Outline



## TO-220AB Part Marking Information

EXAMPLE: THIS IS AN IRF1010  
 LOT CODE 1789  
 ASSEMBLED ON WW 19, 1997  
 IN THE ASSEMBLY LINE "C"  
**Note:** "P" in assembly line  
 position indicates "Lead-Free"



Data and specifications subject to change without notice.  
 This product has been designed and qualified for the industrial market.  
 Qualification Standards can be found on IR's Web site.



**IR WORLD HEADQUARTERS:** 233 Kansas St., El Segundo, California 90245, USA Tel: (310) 252-7105  
 TAC Fax: (310) 252-7903  
 Visit us at [www.irf.com](http://www.irf.com) for sales contact information.08/04

Note: For the most current drawings please refer to the IR website at:  
<http://www.irf.com/package/>