

International  
**IR** Rectifier  
**RADIATION HARDENED  
 POWER MOSFET  
 THRU-HOLE (TO-254AA)**

PD - 93858

**IRHM9260  
 JANSR2N7426  
 200V, P-CHANNEL  
 REF: MIL-PRF-19500/660  
 RAD-Hard™ HEXFET® TECHNOLOGY**

**Product Summary**

Part Number	Radiation Level	RDS(on)	ID	QPL Part Number
IRHM9260	100K Rads (Si)	0.160Ω	-27A	JANSR2N7426
IRHM93260	300K Rads (Si)	0.160Ω	-27A	JANSF2N7426



International Rectifier's RAD-Hard™ HEXFET® MOSFET technology provides high performance power MOSFETs for space applications. This technology has over a decade of proven performance and reliability in satellite applications. These devices have been characterized for both Total Dose and Single Event Effects (SEE). The combination of low RDS(on) and low gate charge reduces the power losses in switching applications such as DC to DC converters and motor control. These devices retain all of the well established advantages of MOSFETs such as voltage control, fast switching, ease of paralleling and temperature stability of electrical parameters.

**Features:**

- Single Event Effect (SEE) Hardened
- Neutron Tolerant
- Identical Pre- and Post-Electrical Test Conditions
- Repetitive Avalanche Ratings
- Dynamic dv/dt Ratings
- Simple Drive Requirements
- Ease of Paralleling
- Hermetically Sealed
- Electrically Isolated
- Ceramic Eyelets
- Light Weight

**Absolute Maximum Ratings**

**Pre-Irradiation**

	Parameter		Units
ID @ VGS = -12V, TC = 25°C	Continuous Drain Current	-27	A
ID @ VGS = -12V, TC = 100°C	Continuous Drain Current	-17	
IDM	Pulsed Drain Current ①	-108	
PD @ TC = 25°C	Max. Power Dissipation	250	W
	Linear Derating Factor	2.0	W/°C
VGS	Gate-to-Source Voltage	±20	V
EAS	Single Pulse Avalanche Energy ②	500	mJ
IAR	Avalanche Current ①	-27	A
EAR	Repetitive Avalanche Energy ①	25	mJ
dv/dt	Peak Diode Recovery dv/dt ③	-9.0	V/ns
TJ	Operating Junction	-55 to 150	°C
TSTG	Storage Temperature Range		
	Lead Temperature	300 (0.063in./1.6mm from case for 10s)	
	Weight	9.3 (Typical)	g

For footnotes refer to the last page

www.irf.com

**Electrical Characteristics @ T<sub>j</sub> = 25°C (Unless Otherwise Specified)**

	Parameter	Min	Typ	Max	Units	Test Conditions
B <sub>V</sub> D <sub>SS</sub>	Drain-to-Source Breakdown Voltage	-200	—	—	V	V <sub>GS</sub> = 0V, I <sub>D</sub> = -1.0mA
ΔB <sub>V</sub> D <sub>SS</sub> /ΔT <sub>J</sub>	Temperature Coefficient of Breakdown Voltage	—	-0.28	—	V/°C	Reference to 25°C, I <sub>D</sub> = -1.0mA
R <sub>D</sub> S(on)	Static Drain-to-Source On-State Resistance	—	—	0.160	Ω	V <sub>GS</sub> = -12V, I <sub>D</sub> = -17A ④
V <sub>GS(th)</sub>	Gate Threshold Voltage	-2.0	—	-4.0	V	V <sub>DS</sub> = V <sub>GS</sub> , I <sub>D</sub> = -1.0mA
g <sub>fs</sub>	Forward Transconductance	13	—	—	S (⑦)	V <sub>DS</sub> > -15V, I <sub>DS</sub> = -17A ④
I <sub>DSS</sub>	Zero Gate Voltage Drain Current	—	—	-25	μA	V <sub>DS</sub> = -160V, V <sub>GS</sub> = 0V
		—	—	-250		V <sub>DS</sub> = -160V, V <sub>GS</sub> = 0V, T <sub>J</sub> = 125°C
I <sub>GSS</sub>	Gate-to-Source Leakage Forward	—	—	-100	nA	V <sub>GS</sub> = -20V
I <sub>GSS</sub>	Gate-to-Source Leakage Reverse	—	—	100		V <sub>GS</sub> = 20V
Q <sub>g</sub>	Total Gate Charge	—	—	300	nC	V <sub>GS</sub> = -12V, I <sub>D</sub> = -27A
Q <sub>gs</sub>	Gate-to-Source Charge	—	—	60		V <sub>DS</sub> = -100V
Q <sub>gd</sub>	Gate-to-Drain ("Miller") Charge	—	—	70		
t <sub>d(on)</sub>	Turn-On Delay Time	—	—	37	ns	V <sub>DD</sub> = -100V, I <sub>D</sub> = -27A R <sub>G</sub> = 2.35Ω
t <sub>r</sub>	Rise Time	—	—	83		
t <sub>d(off)</sub>	Turn-Off Delay Time	—	—	140		
t <sub>f</sub>	Fall Time	—	—	172		
LS + LD	Total Inductance	—	6.8	—	nH	Measured from Drain lead (6mm /0.25in. from package) to Source lead (6mm /0.25in. from package) with Source wires internally bonded from Source Pin to Drain Pad
C <sub>iss</sub>	Input Capacitance	—	6220	—	pF	V <sub>GS</sub> = 0V, V <sub>DS</sub> = -25V f = 1.0MHz
C <sub>oss</sub>	Output Capacitance	—	903	—		
C <sub>rss</sub>	Reverse Transfer Capacitance	—	150	—		

**Source-Drain Diode Ratings and Characteristics**

	Parameter	Min	Typ	Max	Units	Test Conditions
I <sub>S</sub>	Continuous Source Current (Body Diode)	—	—	-27	A	
I <sub>SM</sub>	Pulse Source Current (Body Diode) ①	—	—	-108		
V <sub>SD</sub>	Diode Forward Voltage	—	—	-3.3	V	T <sub>j</sub> = 25°C, I <sub>S</sub> = -27A, V <sub>GS</sub> = 0V ④
t <sub>rr</sub>	Reverse Recovery Time	—	—	600	ns	T <sub>j</sub> = 25°C, I <sub>F</sub> = -27A, di/dt ≥ 100A/μs
Q <sub>R</sub> R	Reverse Recovery Charge	—	—	10	μC	V <sub>DD</sub> ≤ -50V ④
t <sub>on</sub>	Forward Turn-On Time	Intrinsic turn-on time is negligible. Turn-on speed is substantially controlled by LS + LD.				

**Thermal Resistance**

	Parameter	Min	Typ	Max	Units	Test Conditions
R <sub>thJC</sub>	Junction-to-Case	—	—	0.50	°C/W	Typical socket mount
R <sub>thCS</sub>	Case-to-Sink	—	0.21	—		
R <sub>thJA</sub>	Junction-to-Ambient	—	—	48		

Note: Corresponding Spice and Saber models are available on the G&S Website.

For footnotes refer to the last page

## Radiation Characteristics

## IRHM9260, JANSR2N7426

International Rectifier Radiation Hardened MOSFETs are tested to verify their radiation hardness capability. The hardness assurance program at International Rectifier is comprised of two radiation environments. Every manufacturing lot is tested for total ionizing dose (per notes 5 and 6) using the TO-3 package. Both pre- and post-irradiation performance are tested and specified using the same drive circuitry and test conditions in order to provide a direct comparison.

**Table 1. Electrical Characteristics @ Tj = 25°C, Post Total Dose Irradiation ⑤⑥**

	Parameter	100K Rads(Si) <sup>1</sup>		300K Rads (Si) <sup>2</sup>		Units	Test Conditions
		Min	Max	Min	Max		
BV <sub>DSS</sub>	Drain-to-Source Breakdown Voltage	-200	—	-200	—	V	V <sub>GS</sub> = 0V, I <sub>D</sub> = -1.0mA
V <sub>GS(th)</sub>	Gate Threshold Voltage ④	-2.0	-4.0	-2.0	-5.0		V <sub>GS</sub> = V <sub>DS</sub> , I <sub>D</sub> = -1.0mA
I <sub>GSS</sub>	Gate-to-Source Leakage Forward	—	-100	—	-100	nA	V <sub>GS</sub> = -20V
I <sub>GSS</sub>	Gate-to-Source Leakage Reverse	—	100	—	100		V <sub>GS</sub> = 20 V
I <sub>DSS</sub>	Zero Gate Voltage Drain Current	—	-25	—	-25	μA	V <sub>DS</sub> = -160V, V <sub>GS</sub> = 0V
R <sub>DS(on)</sub>	Static Drain-to-Source ④ On-State Resistance (TO-3)	—	0.154	—	0.154	Ω	V <sub>GS</sub> = -12V, I <sub>D</sub> = -17A
R <sub>DS(on)</sub>	Static Drain-to-Source ④ On-State Resistance (TO-254)	—	0.160	—	0.160	Ω	V <sub>GS</sub> = -12V, I <sub>D</sub> = -17A
V <sub>SD</sub>	Diode Forward Voltage ④	—	-3.3	—	-3.3	V	V <sub>GS</sub> = 0V, I <sub>S</sub> = -27A

1. Part number IRHM9260

2. Part number IRHM93260

International Rectifier radiation hardened MOSFETs have been characterized in heavy ion environment for Single Event Effects (SEE). Single Event Effects characterization is illustrated in Fig. a and Table 2.

**Table 2. Single Event Effect Safe Operating Area**

Ion	LET MeV/(mg/cm <sup>2</sup> )	Energy (MeV)	Range (μm)	V <sub>DS</sub> (V)				
				@ V <sub>GS</sub> = 0V	@ V <sub>GS</sub> = 5V	@ V <sub>GS</sub> = 10V	@ V <sub>GS</sub> = 15V	@ V <sub>GS</sub> = 20V
Cu	28.0	285	43.0	-200	-200	-200	-200	—
Br	36.8	305	39.0	-200	-200	-125	-75	—

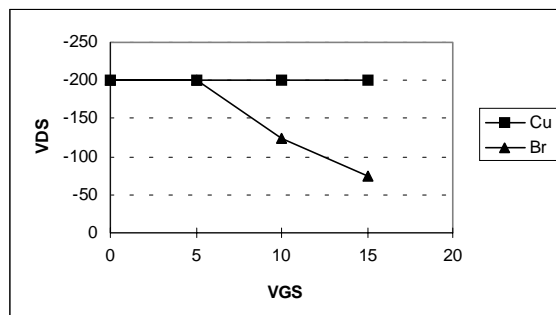

**Fig a. Single Event Effect, Safe Operating Area**

For footnotes refer to the last page

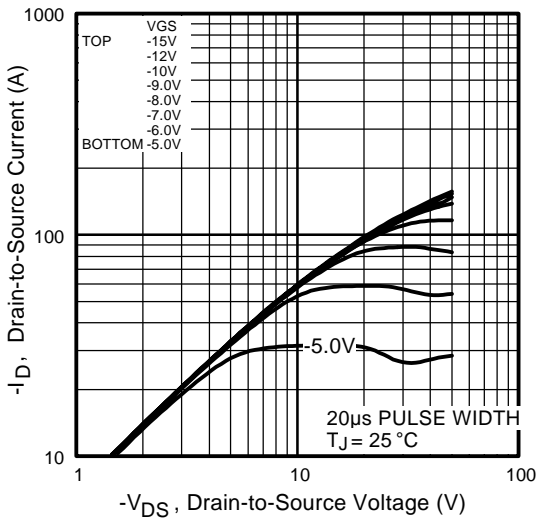

Fig 1. Typical Output Characteristics

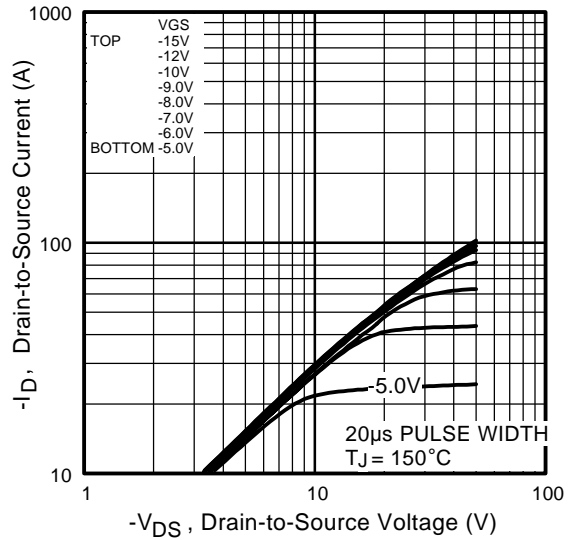

Fig 2. Typical Output Characteristics

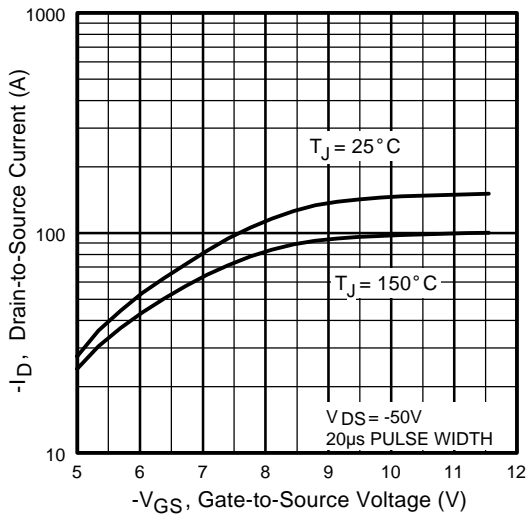

Fig 3. Typical Transfer Characteristics

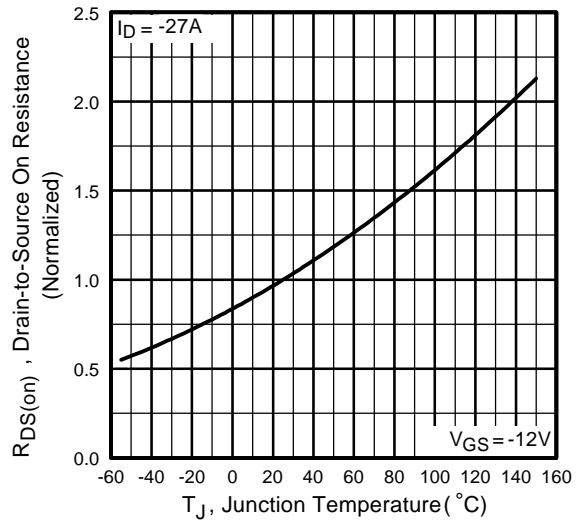

Fig 4. Normalized On-Resistance Vs. Temperature

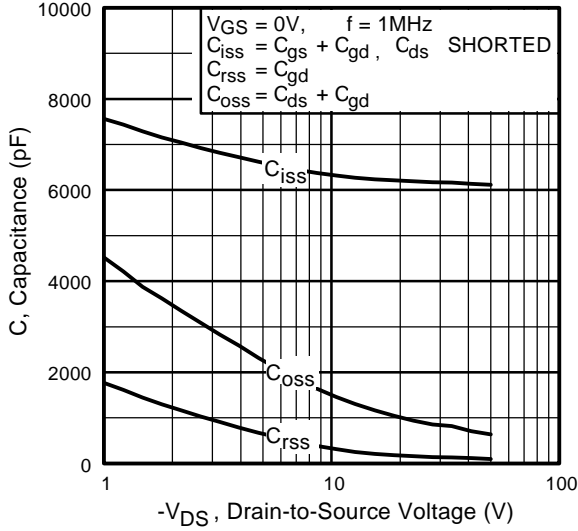

Fig 5. Typical Capacitance Vs. Drain-to-Source Voltage

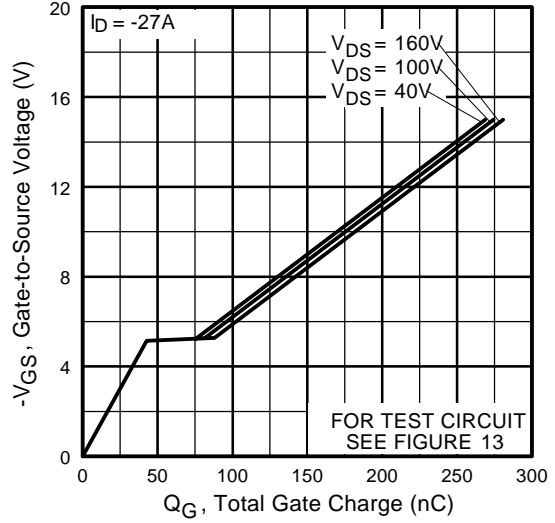

Fig 6. Typical Gate Charge Vs. Gate-to-Source Voltage

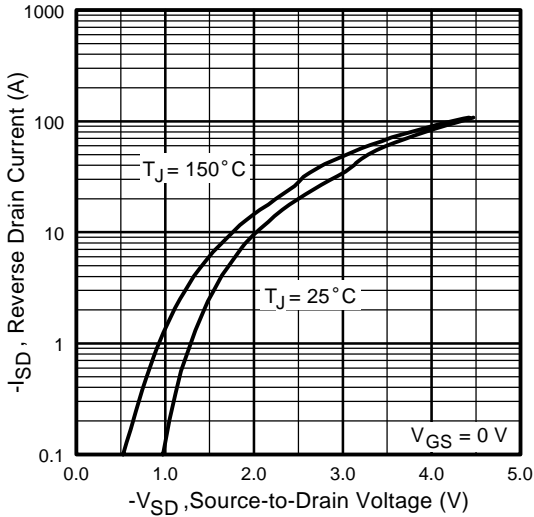

Fig 7. Typical Source-Drain Diode Forward Voltage

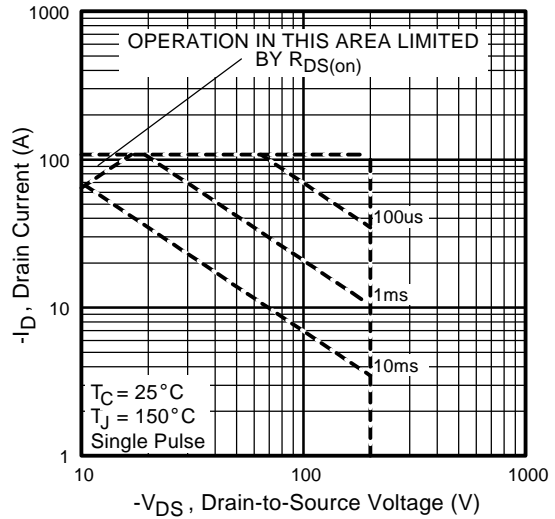

Fig 8. Maximum Safe Operating Area

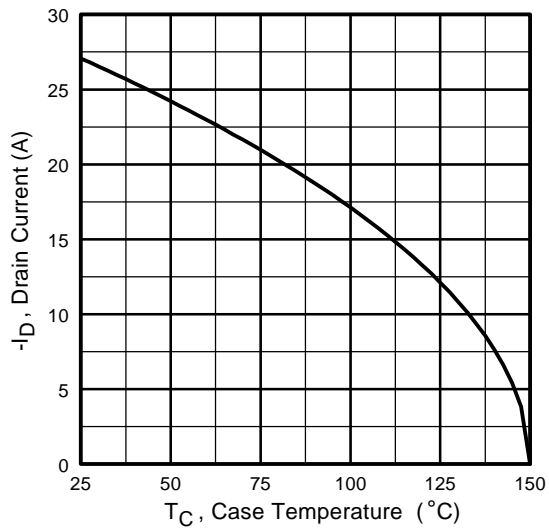

Fig 9. Maximum Drain Current Vs. Case Temperature

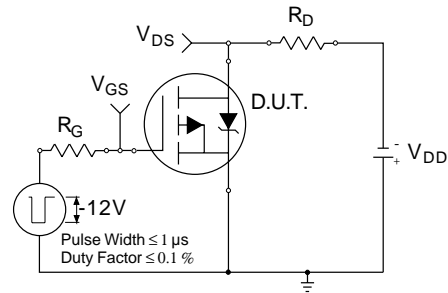

Fig 10a. Switching Time Test Circuit

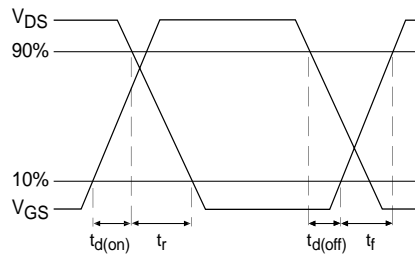

Fig 10b. Switching Time Waveforms

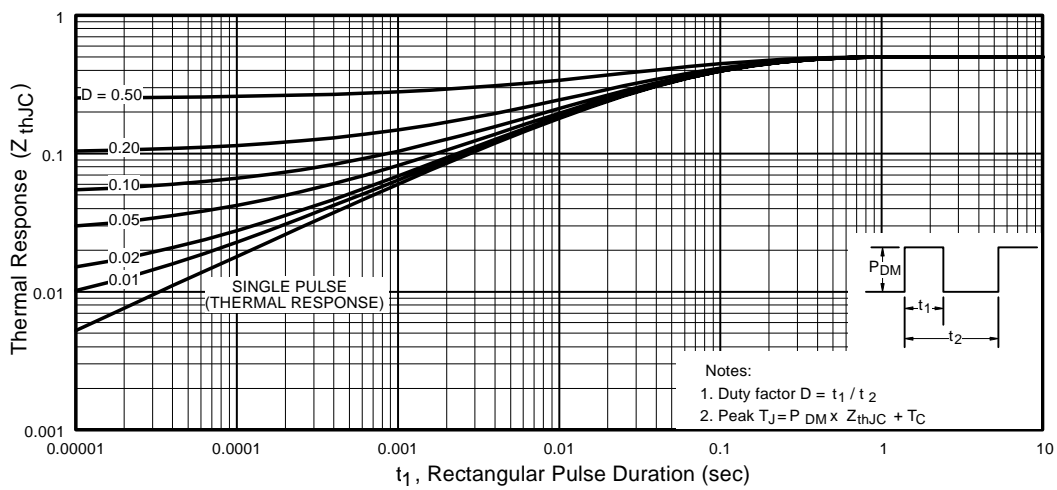
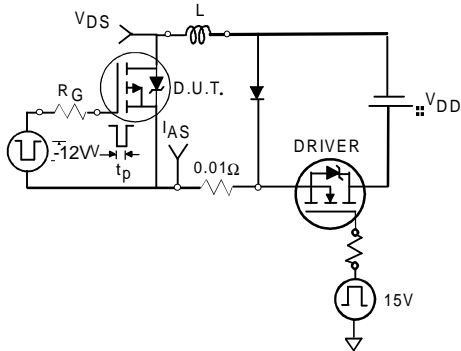

Fig 11. Maximum Effective Transient Thermal Impedance, Junction-to-Case

**Pre-Irradiation**

**IRHM9260, JANSR2N7426**



**Fig 12a.** Unclamped Inductive Test Circuit

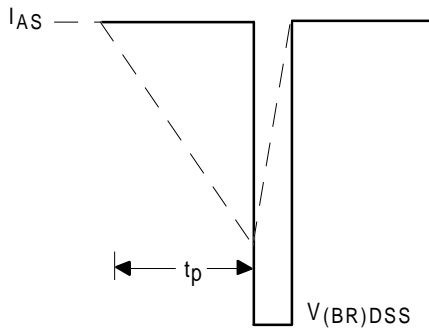

**Fig 12b.** Unclamped Inductive Waveforms

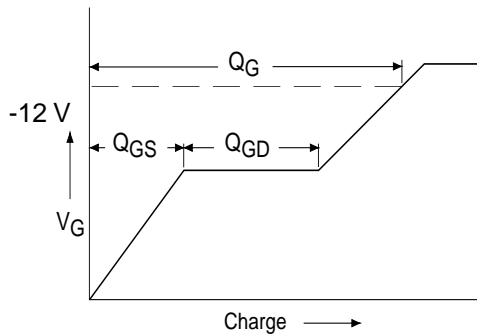

**Fig 13a.** Basic Gate Charge Waveform

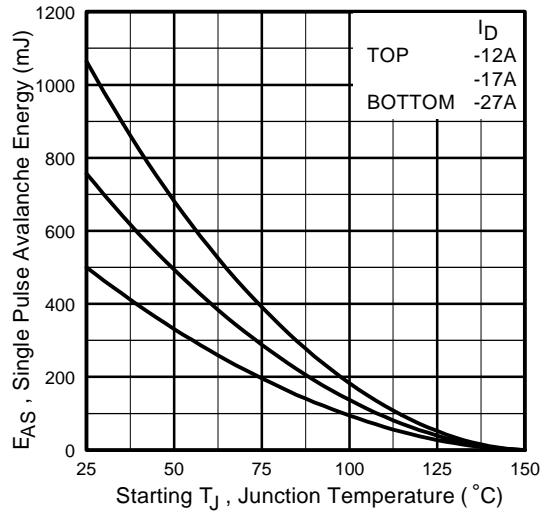

**Fig 12c.** Maximum Avalanche Energy Vs. Drain Current

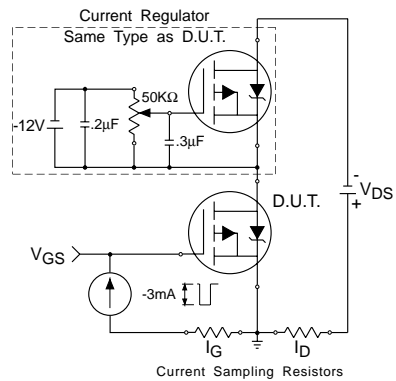
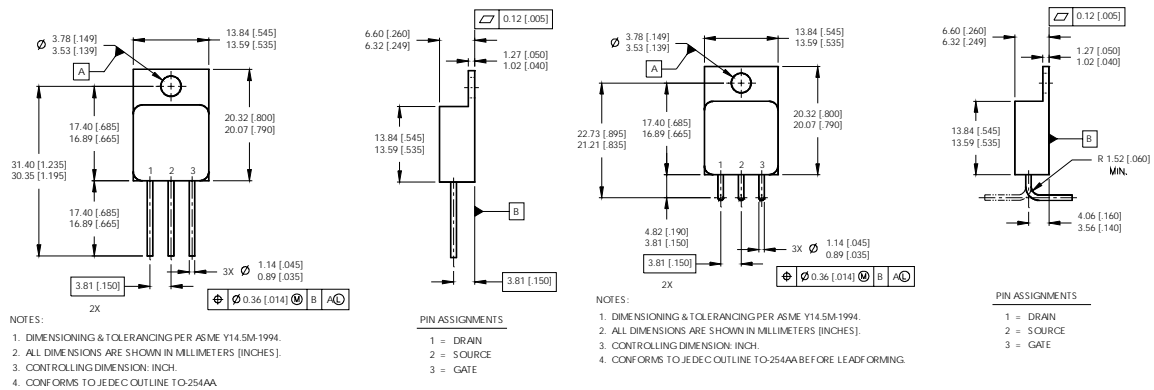

**Fig 13b.** Gate Charge Test Circuit

**Footnotes:**

- ① Repetitive Rating; Pulse width limited by maximum junction temperature.
- ②  $V_{DD} = -50V$ , starting  $T_J = 25^\circ C$ ,  $L = 3.3mH$ , Peak  $I_L = -27A$ ,  $V_{GS} = -12V$
- ③  $I_{SD} \leq -27A$ ,  $di/dt \leq -280A/\mu s$ ,  $V_{DD} \leq -200V$ ,  $T_J \leq 150^\circ C$
- ④ Pulse width  $\leq 300 \mu s$ ; Duty Cycle  $\leq 2\%$
- ⑤ **Total Dose Irradiation with  $V_{GS}$  Bias.**  
-12 volt  $V_{GS}$  applied and  $V_{DS} = 0$  during irradiation per MIL-STD-750, method 1019, condition A
- ⑥ **Total Dose Irradiation with  $V_{DS}$  Bias.**  
-160 volt  $V_{DS}$  applied and  $V_{GS} = 0$  during irradiation per MIL-STD-750, method 1019, condition A

**Case Outline and Dimensions — TO-254AA**



**CAUTION**

**BERYLLIA WARNING PER MIL-PRF-19500**

Packages containing beryllia shall not be ground, sandblasted, machined, or have other operations performed on them which will produce beryllia or beryllium dust. Furthermore, beryllium oxide packages shall not be placed in acids that will produce fumes containing beryllium.



**IR WORLD HEADQUARTERS:** 233 Kansas St., El Segundo, California 90245, USA Tel: (310) 252-7105  
**IR EUROPEAN REGIONAL CENTRE:** 439/445 Godstone Rd, Whyteleafe, Surrey CR3 OBL, UK Tel: ++ 44 (0)20 8645 8000  
**IR CANADA:** 15 Lincoln Court, Brampton, Ontario L6T3Z2, Tel: (905) 453 2200  
**IR GERMANY:** Saalburgstrasse 157, 61350 Bad Homburg Tel: ++ 49 (0) 6172 96590  
**IR ITALY:** Via Liguria 49, 10071 Borgaro, Torino Tel: ++ 39 011 451 0111  
**IR JAPAN:** K&H Bldg., 2F, 30-4 Nishi-Ikebukuro 3-Chome, Toshima-Ku, Tokyo 171 Tel: 81 (0)3 3983 0086  
**IR SOUTHEAST ASIA:** 1 Kim Seng Promenade, Great World City West Tower, 13-11, Singapore 237994 Tel: ++ 65 (0)838 4630  
**IR TAIWAN:** 16 Fl. Suite D. 207, Sec. 2, Tun Haw South Road, Taipei, 10673 Tel: 886-(0)2 2377 9936  
*Data and specifications subject to change without notice. 11/00*