

**RADIATION HARDENED  
 POWER MOSFET  
 SURFACE MOUNT (SMD-0.2)**

**IRHNM597110  
 100V, P-CHANNEL  
 **TECHNOLOGY****

**Product Summary**

Part Number	Radiation Level	RDS(on)	ID
IRHNM597110	100K Rads (Si)	1.2Ω	-3.1A
IRHNM593110	300K Rads (Si)	1.2Ω	-3.1A

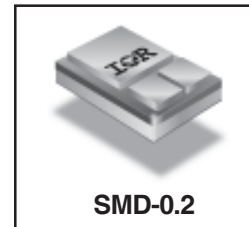

International Rectifier's R5™ technology provides high performance power MOSFETs for space applications. These devices have been characterized for Single Event Effects (SEE) with useful performance up to an LET of 80 (MeV/(mg/cm<sup>2</sup>)). The combination of low RDS(on) and low gate charge reduces the power losses in switching applications such as DC to DC converters and motor control. These devices retain all of the well established advantages of MOSFETs such as voltage control, fast switching, ease of paralleling and temperature stability of electrical parameters.

**Features:**

- Single Event Effect (SEE) Hardened
- Low RDS(on)
- Low Total Gate Charge
- Simple Drive Requirements
- Ease of Paralleling
- Hermetically Sealed
- Surface Mount
- Ceramic Package
- Light Weight

**Absolute Maximum Ratings**

**Pre-Irradiation**

	Parameter		Units
ID@ VGS = -12V, TC = 25°C	Continuous Drain Current	-3.1	A
ID@ VGS = -12V, TC = 100°C	Continuous Drain Current	-2.0	
IDM	Pulsed Drain Current ①	-12.4	
PD @ TC = 25°C	Max. Power Dissipation	23	W
	Linear Derating Factor	0.18	W/°C
VGS	Gate-to-Source Voltage	±20	V
EAS	Single Pulse Avalanche Energy ②	28	mJ
IAR	Avalanche Current ①	-3.1	A
EAR	Repetitive Avalanche Energy ①	2.3	mJ
dv/dt	Peak Diode Recovery dv/dt ③	-21	V/ns
TJ	Operating Junction	-55 to 150	°C
TSTG	Storage Temperature Range		
	Pckg. Mounting Surface Temp.	300 (for 5s)	
	Weight	0.25 (Typical)	g

For footnotes refer to the last page

**Electrical Characteristics @ T<sub>j</sub> = 25°C (Unless Otherwise Specified)**

	Parameter	Min	Typ	Max	Units	Test Conditions
BV <sub>DSS</sub>	Drain-to-Source Breakdown Voltage	-100	—	—	V	V <sub>GS</sub> = 0V, I <sub>D</sub> = -1.0mA
ΔBV <sub>DSS</sub> /ΔT <sub>J</sub>	Temperature Coefficient of Breakdown Voltage	—	-0.13	—	V/°C	Reference to 25°C, I <sub>D</sub> = -1.0mA
R <sub>DS(on)</sub>	Static Drain-to-Source On-State Resistance	—	—	1.2	Ω	V <sub>GS</sub> = -12V, I <sub>D</sub> = -2.0A ④
V <sub>GS(th)</sub>	Gate Threshold Voltage	-2.0	—	-4.0	V	V <sub>DS</sub> = V <sub>GS</sub> , I <sub>D</sub> = -1.0mA
ΔV <sub>GS(th)</sub> /ΔT <sub>J</sub>	Gate Threshold Voltage Coefficient	—	4.88	—	mV/°C	
g <sub>fs</sub>	Forward Transconductance	1.9	—	—	S	V <sub>DS</sub> = -15V, I <sub>DS</sub> = -2.0A ④
I <sub>DSS</sub>	Zero Gate Voltage Drain Current	—	—	-10	μA	V <sub>DS</sub> = -80V, V <sub>GS</sub> = 0V
		—	—	-25		V <sub>DS</sub> = -80V, V <sub>GS</sub> = 0V, T <sub>J</sub> = 125°C
I <sub>GSS</sub>	Gate-to-Source Leakage Forward	—	—	-100	nA	V <sub>GS</sub> = -20V
I <sub>GSS</sub>	Gate-to-Source Leakage Reverse	—	—	100	nA	V <sub>GS</sub> = 20V
Q <sub>g</sub>	Total Gate Charge	—	—	11	nC	V <sub>GS</sub> = -12V, I <sub>D</sub> = -3.1A V <sub>DS</sub> = -50V
Q <sub>gs</sub>	Gate-to-Source Charge	—	—	3.0		
Q <sub>gd</sub>	Gate-to-Drain ('Miller') Charge	—	—	4.0		
t <sub>d(on)</sub>	Turn-On Delay Time	—	—	18	ns	V <sub>DD</sub> = -50V, I <sub>D</sub> = -3.1A, V <sub>GS</sub> = -12V, R <sub>G</sub> = 7.5Ω
t <sub>r</sub>	Rise Time	—	—	26		
t <sub>d(off)</sub>	Turn-Off Delay Time	—	—	12		
t <sub>f</sub>	Fall Time	—	—	12		
L <sub>S</sub> + L <sub>D</sub>	Total Inductance	—	6.8	—	nH	Measured from the center of drain pad to center of source pad
C <sub>iss</sub>	Input Capacitance	—	379	—	pF	V <sub>GS</sub> = 0V, V <sub>DS</sub> = -25V f = 100KHz
C <sub>oss</sub>	Output Capacitance	—	98	—		
C <sub>rss</sub>	Reverse Transfer Capacitance	—	9.5	—		
R <sub>g</sub>	Gate Resistance	—	24	—	Ω	f = 1.0MHz, open drain

**Source-Drain Diode Ratings and Characteristics**

	Parameter	Min	Typ	Max	Units	Test Conditions
I <sub>S</sub>	Continuous Source Current (Body Diode)	—	—	-3.1	A	T <sub>j</sub> = 25°C, I <sub>S</sub> = -3.1A, V <sub>GS</sub> = 0V ④
I <sub>SM</sub>	Pulse Source Current (Body Diode) ①	—	—	-12.4		
V <sub>SD</sub>	Diode Forward Voltage	—	—	-5.0	V	T <sub>j</sub> = 25°C, I <sub>F</sub> = -3.1A, di/dt ≤ -100A/μs
t <sub>rr</sub>	Reverse Recovery Time	—	—	100	ns	V <sub>DD</sub> ≤ -50V ④
Q <sub>RR</sub>	Reverse Recovery Charge	—	—	271	nC	
t <sub>on</sub>	Forward Turn-On Time	Intrinsic turn-on time is negligible. Turn-on speed is substantially controlled by L <sub>S</sub> + L <sub>D</sub> .				

**Thermal Resistance**

	Parameter	Min	Typ	Max	Units	Test Conditions
R <sub>thJC</sub>	Junction-to-Case	—	—	5.4	°C/W	

**Note:** Corresponding Spice and Saber models are available on International Rectifier website.

For footnotes refer to the last page

## Radiation Characteristics

IRHNM597110

International Rectifier Radiation Hardened MOSFETs are tested to verify their radiation hardness capability. The hardness assurance program at International Rectifier is comprised of two radiation environments. Every manufacturing lot is tested for total ionizing dose (per notes 5 and 6) using the TO-3 package. Both pre- and post-irradiation performance are tested and specified using the same drive circuitry and test conditions in order to provide a direct comparison.

**Table 1. Electrical Characteristics @ Tj = 25°C, Post Total Dose Irradiation ⑤⑥**

	Parameter	100KRads(Si) <sup>1</sup>		300KRads(Si) <sup>2</sup>		Units	Test Conditions
		Min	Max	Min	Max		
BV <sub>DSS</sub>	Drain-to-Source Breakdown Voltage	-100	—	-100	—	V	V <sub>GS</sub> = 0V, I <sub>D</sub> = -1.0mA
V <sub>GS(th)</sub>	Gate Threshold Voltage	-2.0	-4.0	-2.0	-4.0		V <sub>GS</sub> = V <sub>DS</sub> , I <sub>D</sub> = -1.0mA
I <sub>GSS</sub>	Gate-to-Source Leakage Forward	—	-100	—	-100	nA	V <sub>GS</sub> = -20V
I <sub>GSS</sub>	Gate-to-Source Leakage Reverse	—	100	—	100		V <sub>GS</sub> = 20 V
I <sub>DSS</sub>	Zero Gate Voltage Drain Current	—	-10	—	-10	μA	V <sub>DS</sub> = -80V, V <sub>GS</sub> = 0V
R <sub>DS(on)</sub>	Static Drain-to-Source ④ On-State Resistance (TO-3)	—	0.916	—	0.936	Ω	V <sub>GS</sub> = -12V, I <sub>D</sub> = -2.0A
R <sub>DS(on)</sub>	Static Drain-to-Source ④ On-State Resistance (SMD-0.2)	—	1.2	—	1.2	Ω	V <sub>GS</sub> = -12V, I <sub>D</sub> = -2.0A
V <sub>SD</sub>	Diode Forward Voltage ④	—	-5.0	—	-5.0	V	V <sub>GS</sub> = 0V, I <sub>S</sub> = -3.1A

1. Part number IRHNM597110
2. Part number IRHNM593110

International Rectifier radiation hardened MOSFETs have been characterized in heavy ion environment for Single Event Effects (SEE). Single Event Effects characterization is illustrated in Fig. a and Table 2.

**Table 2. Typical Single Event Effect Safe Operating Area**

Ion	LET (MeV/(mg/cm <sup>2</sup> ))	Energy (MeV)	Range (μm)	V <sub>DS</sub> (V)					
				@V <sub>GS</sub> = 0V	@V <sub>GS</sub> = 5V	@V <sub>GS</sub> = 10V	@V <sub>GS</sub> = 15V	@V <sub>GS</sub> = 17.5V	@V <sub>GS</sub> = 20V
Br	37.3	285	36.8	-100	-100	-100	-100	-100	-100
I	59.9	344	32.7	-100	-100	-100	-100	-75	-25
Au	82.3	351	28.5	-100	-100	-100	-30	-	-

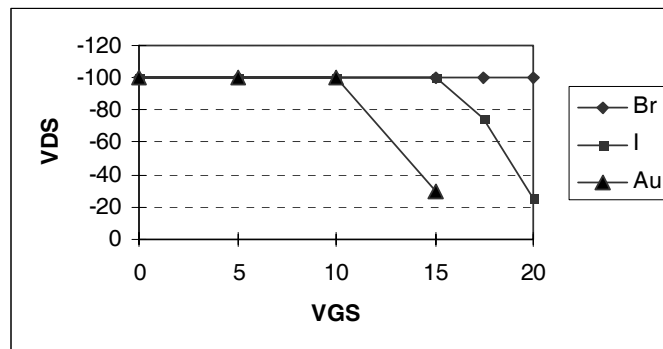

**Fig a. Typical Single Event Effect, Safe Operating Area**

For footnotes refer to the last page

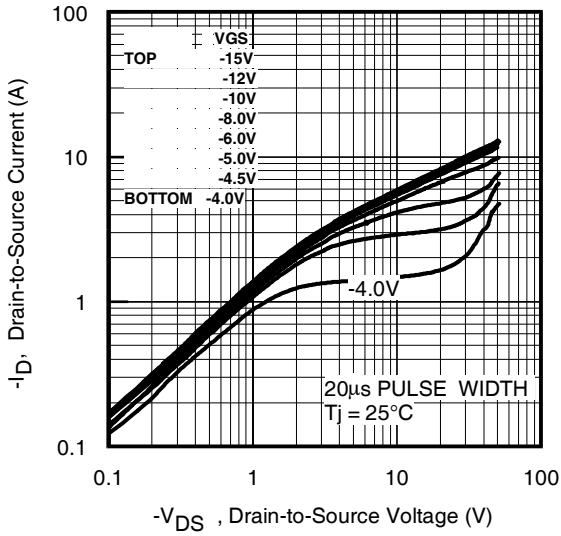

Fig 1. Typical Output Characteristics

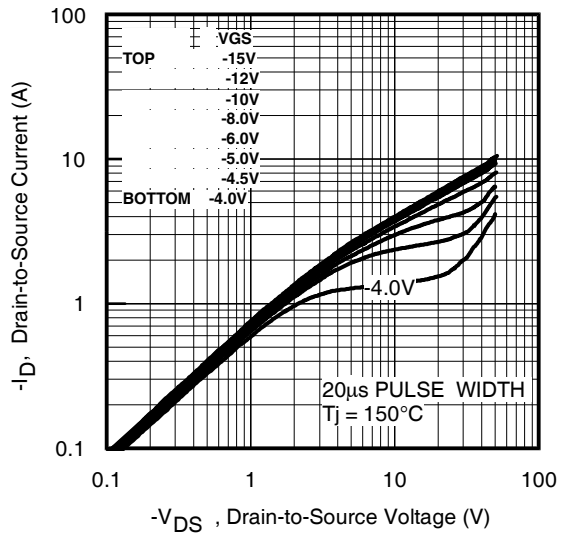

Fig 2. Typical Output Characteristics

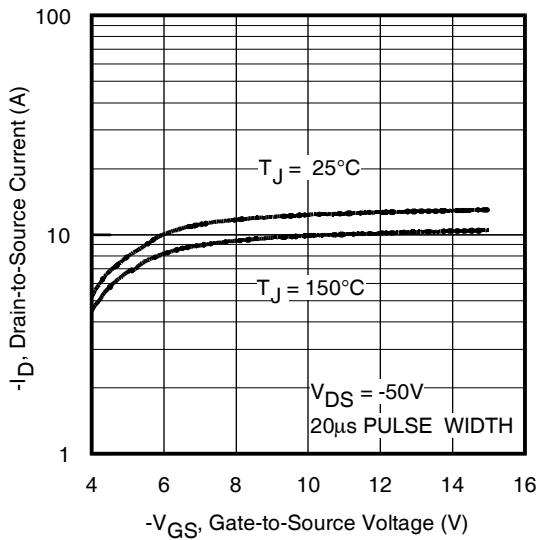

Fig 3. Typical Transfer Characteristics

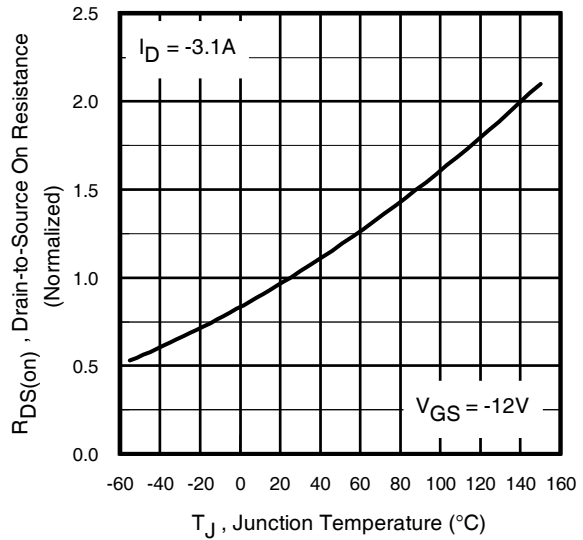
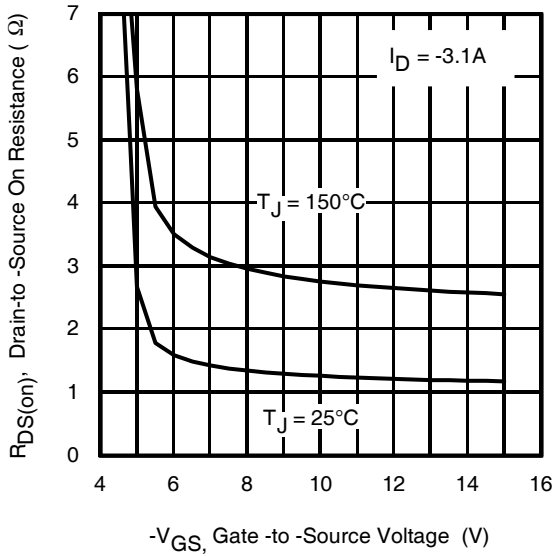
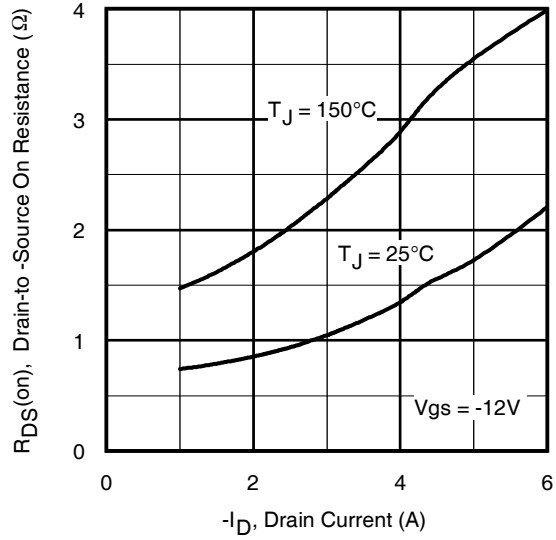

Fig 4. Normalized On-Resistance Vs. Temperature



**Fig 5.** Typical On-Resistance Vs Gate Voltage



**Fig 6.** Typical On-Resistance Vs Drain Current

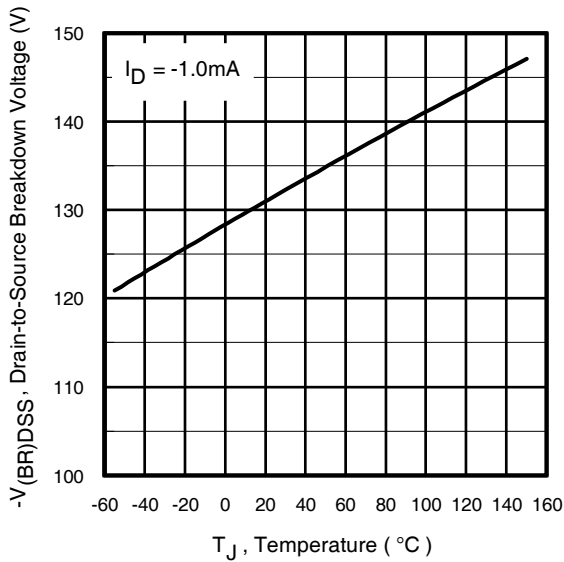

**Fig 7.** Typical Drain-to-Source Breakdown Voltage Vs Temperature

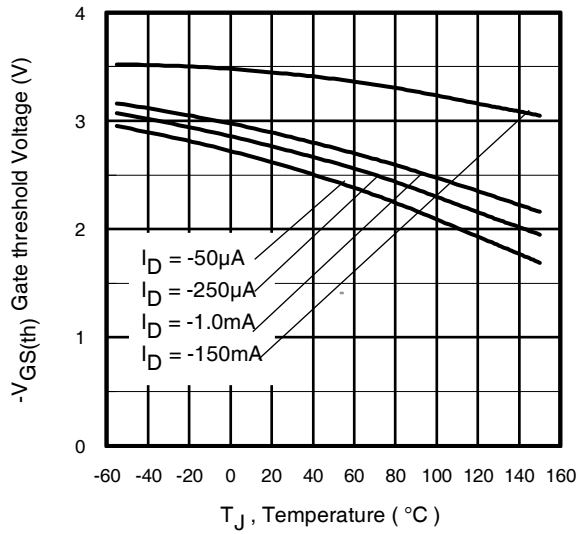

**Fig 8.** Typical Threshold Voltage Vs Temperature

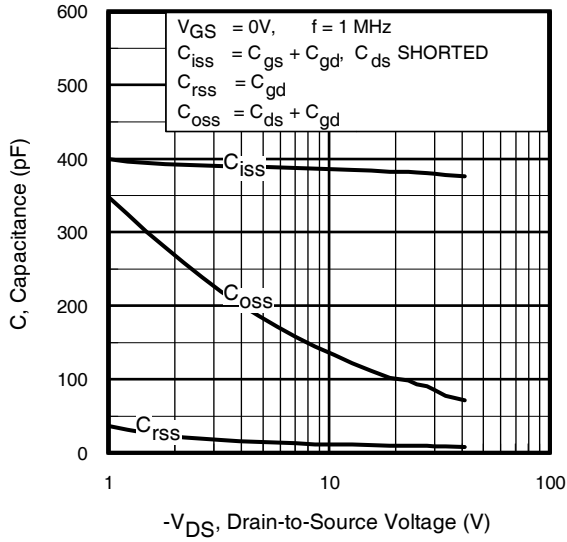

**Fig 9.** Typical Capacitance Vs. Drain-to-Source Voltage

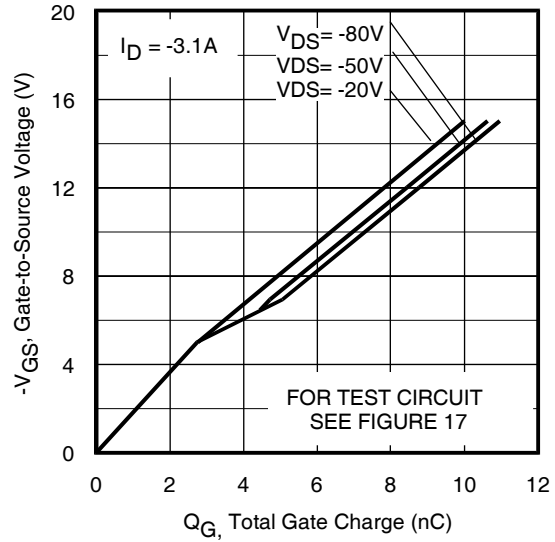

**Fig 10.** Typical Gate Charge Vs. Gate-to-Source Voltage

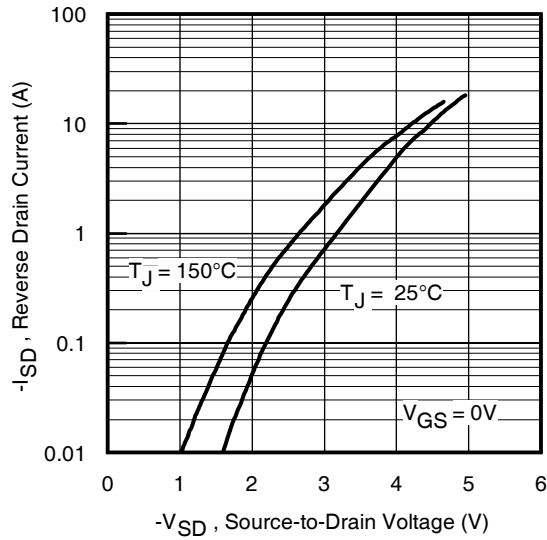

**Fig 11.** Typical Source-Drain Diode Forward Voltage

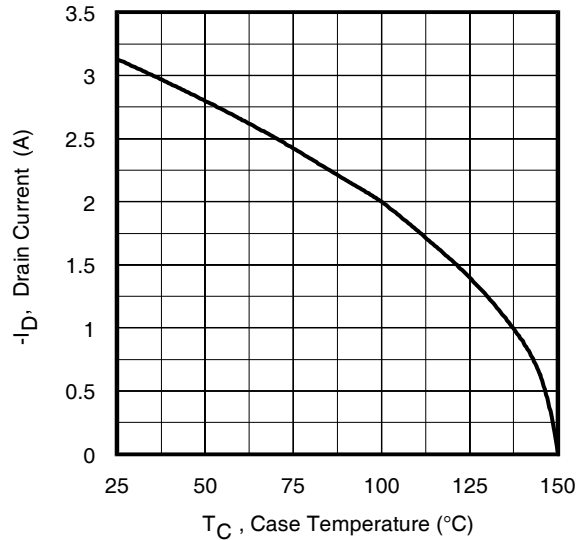

**Fig 12.** Maximum Drain Current Vs. Case Temperature

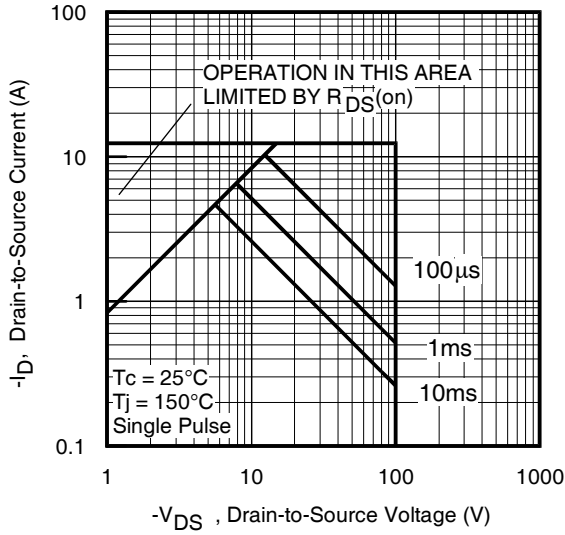

Fig 13. Maximum Safe Operating Area

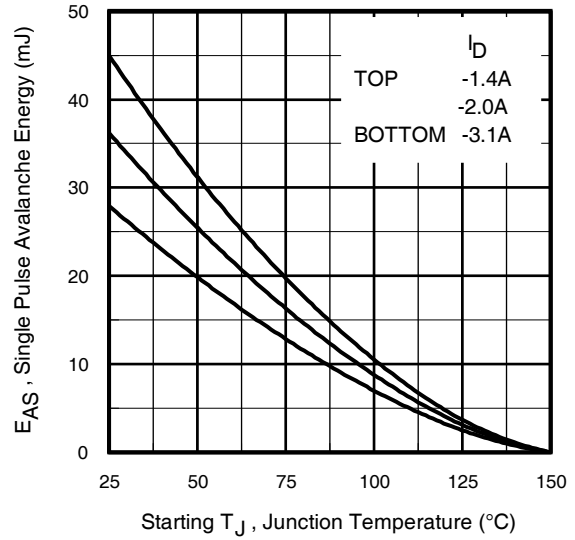

Fig 14. Maximum Avalanche Energy Vs. Drain Current

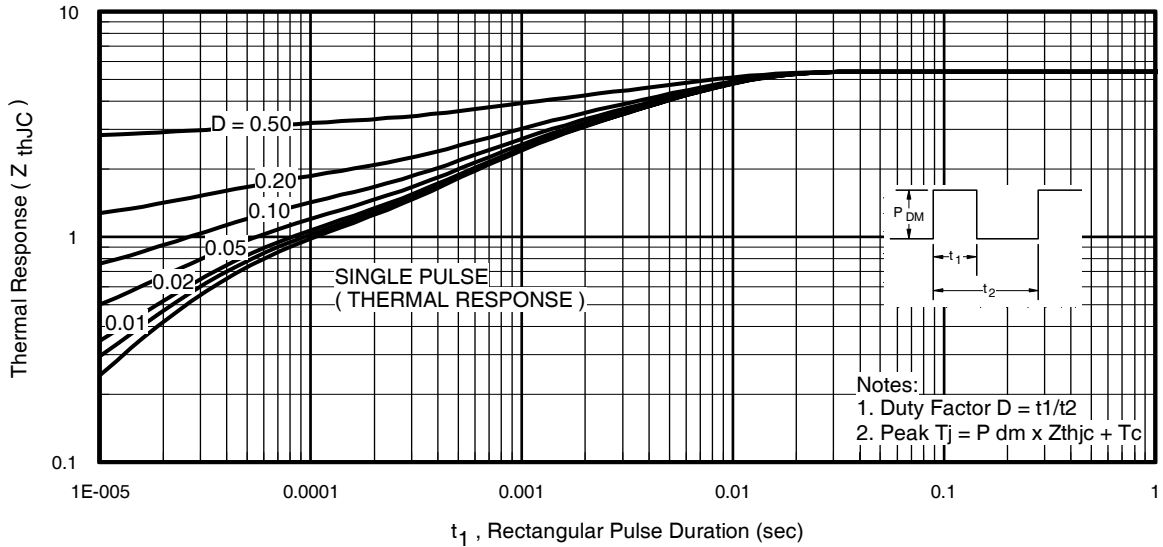

Fig 15. Maximum Effective Transient Thermal Impedance, Junction-to-Case

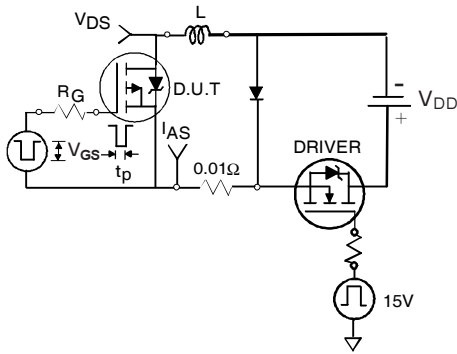

Fig 16a. Unclamped Inductive Test Circuit

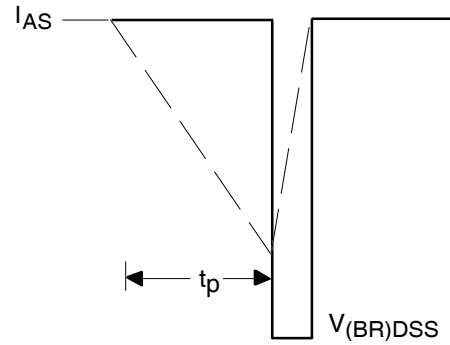

Fig 16b. Unclamped Inductive Waveforms

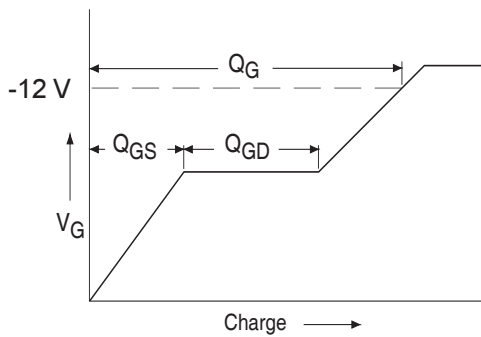

Fig 17a. Basic Gate Charge Waveform

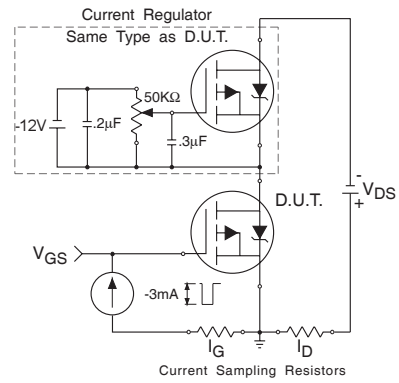

Fig 17b. Gate Charge Test Circuit

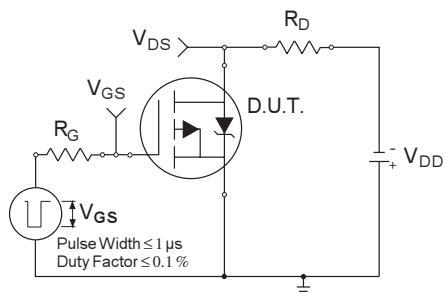

Fig 18a. Switching Time Test Circuit

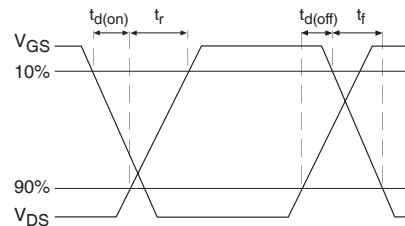

Fig 18b. Switching Time Waveforms



**Footnotes:**

- ① Repetitive Rating; Pulse width limited by maximum junction temperature.
- ②  $V_{DD} = -50V$ , starting  $T_J = 25^\circ C$ ,  $L=5.8$  mH  
Peak  $I_L = -3.1A$ ,  $V_{GS} = -12V$
- ③  $I_{SD} \leq -3.1A$ ,  $di/dt \leq -544A/\mu s$ ,  
 $V_{DD} \leq -100V$ ,  $T_J \leq 150^\circ C$
- ④ Pulse width  $\leq 300 \mu s$ ; Duty Cycle  $\leq 2\%$
- ⑤ **Total Dose Irradiation with  $V_{GS}$  Bias.**  
-12 volt  $V_{GS}$  applied and  $V_{DS} = 0$  during irradiation per MIL-STD-750, method 1019, condition A.
- ⑥ **Total Dose Irradiation with  $V_{DS}$  Bias.**  
-80 volt  $V_{DS}$  applied and  $V_{GS} = 0$  during irradiation per MIL-STD-750, method 1019, condition A.

**Case Outline and Dimensions — SMD-0.2**

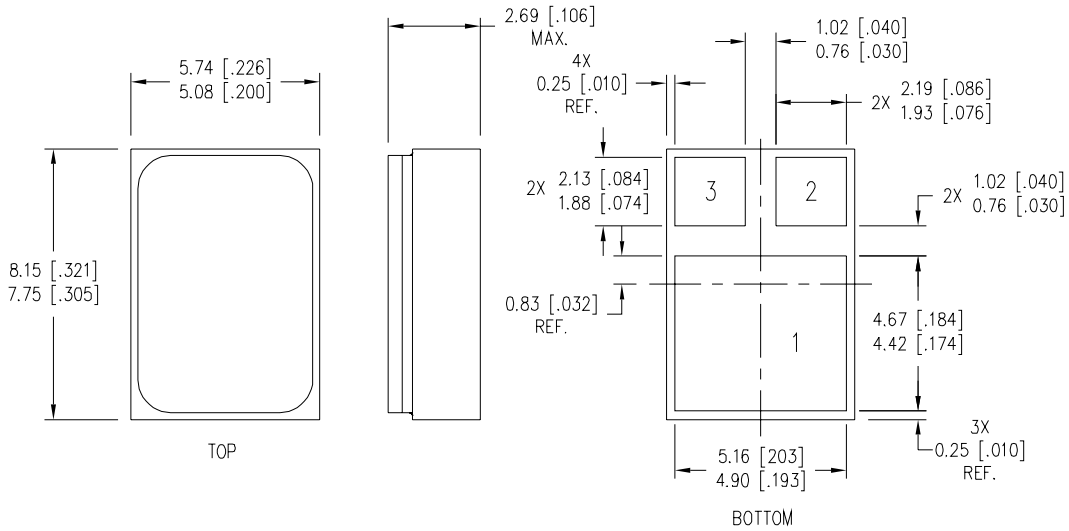

**NOTES:**

- 1. DIMENSIONING & TOLERANCING PER ASME Y14.5M-1994.
- 2. CONTROLLING DIMENSION: INCH.
- 3. DIMENSIONS ARE SHOWN IN MILLIMETERS [INCHES].

**PAD ASSIGNMENT**

- 1 = DRAIN
- 2 = GATE
- 3 = SOURCE

International  
**IR** Rectifier

**IR WORLD HEADQUARTERS:** 233 Kansas St., El Segundo, California 90245, USA Tel: (310) 252-7105  
**IR LEOMINSTER :** 205 Crawford St., Leominster, Massachusetts 01453, USA Tel: (978) 534-5776  
TAC Fax: (310) 252-7903

Visit us at [www.irf.com](http://www.irf.com) for sales contact information.  
Data and specifications subject to change without notice. 12/2007