

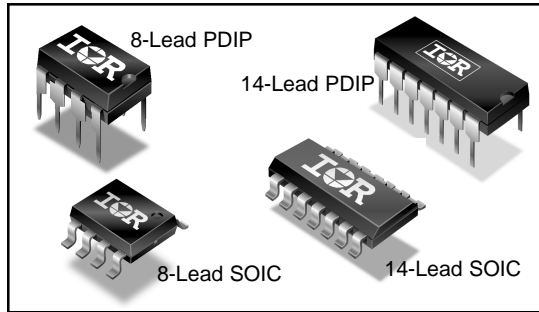
IRS2106/IRS21064(S)PbF

HIGH AND LOW SIDE DRIVER

Features

- Floating channel designed for bootstrap operation
- Fully operational to +600 V
- Tolerant to negative transient voltage, dV/dt immune
- Gate drive supply range from 10 V to 20 V
- Undervoltage lockout for both channels
- 3.3 V, 5 V, and 15 V input logic compatible
- Matched propagation delay for both channels
- Logic and power ground +/- 5 V offset
- Lower di/dt gate driver for better noise immunity
- Outputs in phase with inputs (IRS2106)
- RoHS compliant

Packages



Description

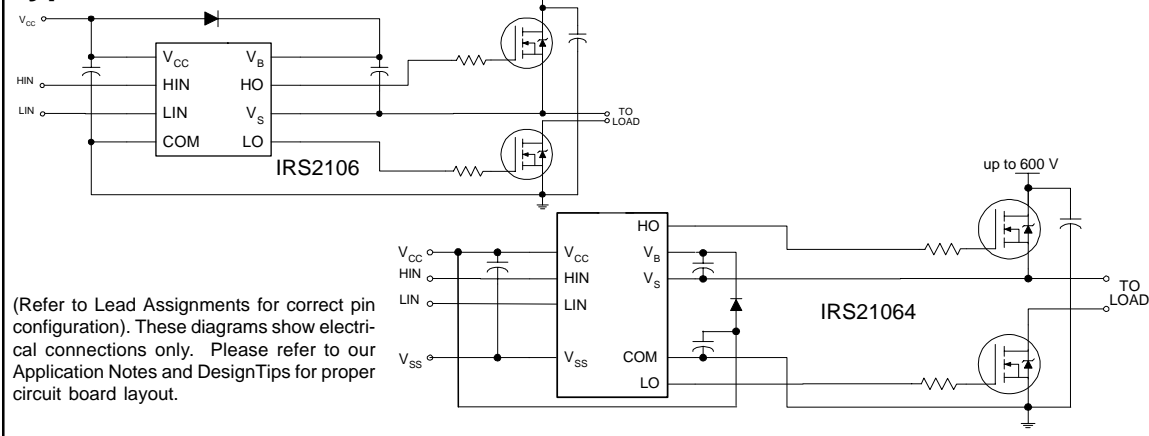
The IRS2106/IRS21064 are high voltage, high speed power MOSFET and IGBT drivers with independent high- and low-side referenced output channels. Proprietary HVIC and latch immune CMOS technologies enable ruggedized monolithic construction. The logic input is compatible with standard CMOS or LSTTL output, down to 3.3 V logic.

The output drivers feature a high pulse current buffer stage designed for minimum driver cross-conduction. The floating channel can be used to drive an N-channel power MOSFET or IGBT in the high side configuration which operates up to 600 V.

Feature Comparison

Part	Input logic	Cross-conduction prevention logic	Deadtime (ns)	Ground Pins	ton/toff (ns)
2106/2301	HIN/LIN	no	none	COM	220/200
21064				Vss/COM	
2108	HIN/LIN	yes	Internal 540	COM	220/200
21084			Programmable 540 - 5000	Vss/COM	
2109/2302	IN/SD	yes	Internal 540	COM	750/200
21094			Programmable 540 - 5000	Vss/COM	
2304	HIN/LIN	yes	Internal 100	COM	160/140

Typical Connection



Absolute Maximum Ratings

Absolute maximum ratings indicate sustained limits beyond which damage to the device may occur. All voltage parameters are absolute voltages referenced to COM. The thermal resistance and power dissipation ratings are measured under board mounted and still air conditions.

Symbol	Definition	Min.	Max.	Units	
V _B	High-side floating absolute voltage	-0.3	625	V	
V _S	High-side floating supply offset voltage	V _B - 25	V _B + 0.3		
V _{HO}	High-side floating output voltage	V _S - 0.3	V _B + 0.3		
V _{CC}	Low-side and logic fixed supply voltage	-0.3	25		
V _{LO}	Low-side output voltage	-0.3	V _{CC} + 0.3		
V _{IN}	Logic input voltage	V _{SS} - 0.3	V _{CC} + 0.3		
V _{SS}	Logic ground (IRS21064 only)	V _{CC} - 25	V _{CC} + 0.3		
dV _S /dt	Allowable offset supply voltage transient	—	50	V/ns	
P _D	Package power dissipation @ T _A ≤ +25 °C	(8 lead PDIP)	—	1.0	W
		(8 lead SOIC)	—	0.625	
		(14 lead PDIP)	—	1.6	
		(14 lead SOIC)	—	1.0	
R _{thJA}	Thermal resistance, junction to ambient	(8 lead PDIP)	—	125	°C/W
		(8 lead SOIC)	—	200	
		(14 lead PDIP)	—	75	
		(14 lead SOIC)	—	120	
T _J	Junction temperature	—	150	°C	
T _S	Storage temperature	-50	150		
T _L	Lead temperature (soldering, 10 seconds)	—	300		

Recommended Operating Conditions

The input/output logic timing diagram is shown in Fig. 1. For proper operation the device should be used within the recommended conditions. The V_S and V_{SS} offset rating are tested with all supplies biased at a 15 V differential.

Symbol	Definition	Min.	Max.	Units
V_B	High-side floating supply absolute voltage	$V_S + 10$	$V_S + 20$	V
V_S	High-side floating supply offset voltage	Note 1	600	
V_{HO}	High-side floating output voltage	V_S	V_B	
V_{CC}	Low-side and logic fixed supply voltage	10	20	
V_{LO}	Low-side output voltage	0	V_{CC}	
V_{IN}	Logic input voltage	V_{SS}	V_{CC}	
V_{SS}	Logic ground (IRS21064 only)	-5	5	
T_A	Ambient temperature	-40	125	°C

Note 1: Logic operational for V_S of -5 V to +600 V. Logic state held for V_S of -5 V to $-V_{BS}$. (Please refer to the Design Tip DT97-3 for more details).

Dynamic Electrical Characteristics

$V_{BIAS} (V_{CC}, V_{BS}) = 15\text{ V}$, $V_{SS} = \text{COM}$, $C_L = 1000\text{ pF}$, $T_A = 25\text{ °C}$.

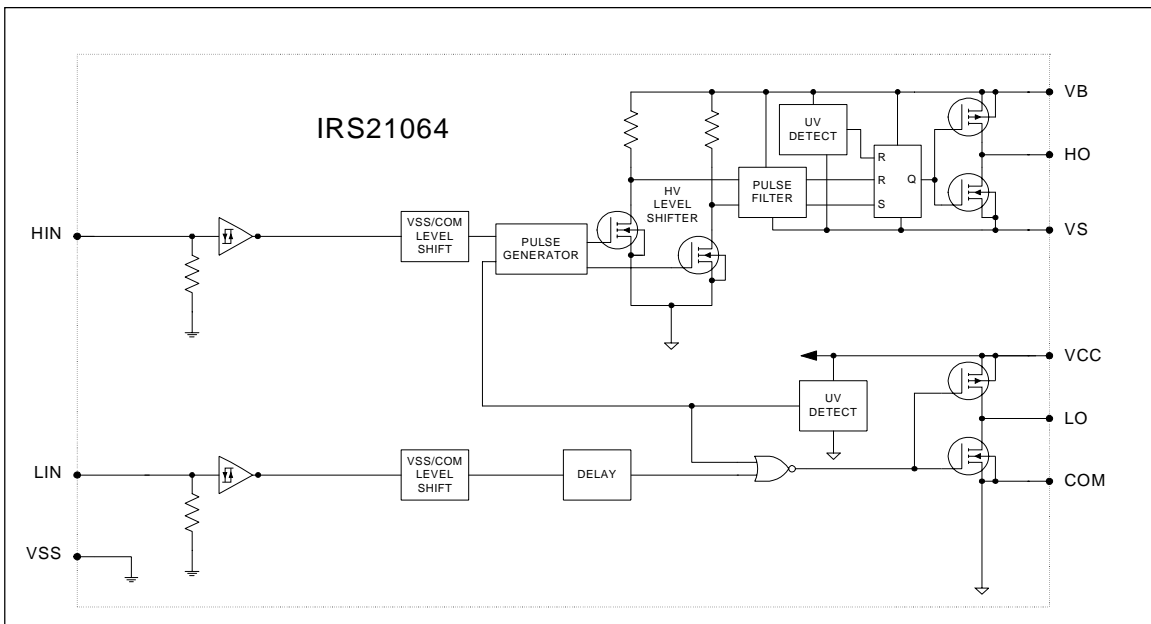
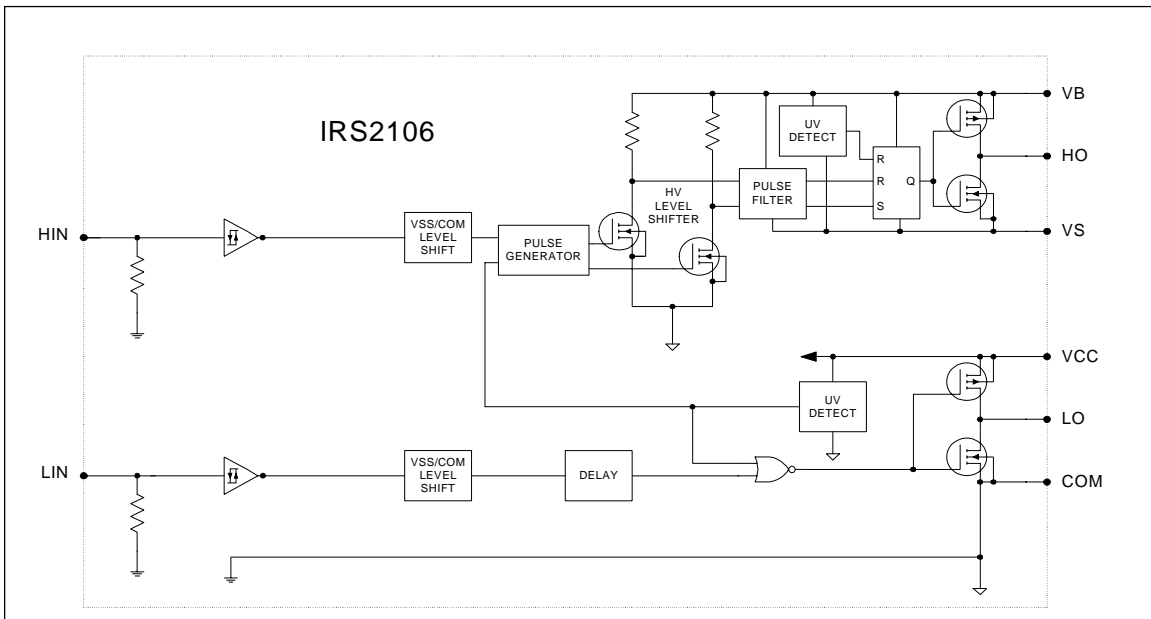
Symbol	Definition	Min.	Typ.	Max.	Units	Test Conditions
t_{on}	Turn-on propagation delay	—	220	300	ns	$V_S = 0\text{ V}$
t_{off}	Turn-off propagation delay	—	200	280		$V_S = 0\text{ V}$ or 600 V
MT	Delay matching, HS & LS turn-on/off	—	0	30		
t_r	Turn-on rise time	—	100	220		$V_S = 0\text{ V}$
t_f	Turn-off fall time	—	35	80		

Static Electrical Characteristics

V_{BIAS} (V_{CC} , V_{BS}) = 15 V, V_{SS} = COM and T_A = 25 °C unless otherwise specified. The V_{IL} , V_{IH} , and I_{IN} parameters are referenced to V_{SS}/COM and are applicable to the respective input leads. The V_O , I_O , and R_{ON} parameters are referenced to COM and are applicable to the respective output leads: HO and LO.

Symbol	Definition	Min.	Typ.	Max.	Units	Test Conditions
V_{IH}	Logic "1" input voltage	2.5	—	—	V	$V_{CC} = 10\text{ V to }20\text{ V}$
V_{IL}	Logic "0" input voltage	—	—	0.8		
V_{OH}	High level output voltage, $V_{BIAS} - V_O$	—	0.05	0.2		$I_O = 2\text{ mA}$
V_{OL}	Low level output voltage, V_O	—	0.02	0.1		
I_{LK}	Offset supply leakage current	—	—	50	μA	$V_B = V_S = 600\text{ V}$
I_{QBS}	Quiescent V_{BS} supply current	20	75	130		$V_{IN} = 0\text{ V or }5\text{ V}$
I_{QCC}	Quiescent V_{CC} supply current	60	120	180		
I_{IN+}	Logic "1" input bias current $V_{IN} = 5\text{ V}$	—	5	20		
I_{IN-}	Logic "0" input bias current $V_{IN} = 0\text{ V}$	—	—	5		
V_{CCUV+} V_{BSUV+}	V_{CC} and V_{BS} supply undervoltage positive going threshold	8.0	8.9	9.8	V	
V_{CCUV-} V_{BSUV-}	V_{CC} and V_{BS} supply undervoltage negative going threshold	7.4	8.2	9.0		
V_{CCUVH} V_{BSUVH}	Hysteresis	0.3	0.7	—		
I_{O+}	Output high short circuit pulsed current	130	290	—	mA	$V_O = 0\text{ V},$ $PW \leq 10\ \mu\text{s}$
I_{O-}	Output low short circuit pulsed current	270	600	—		$V_O = 15\text{ V},$ $PW \leq 10\ \mu\text{s}$

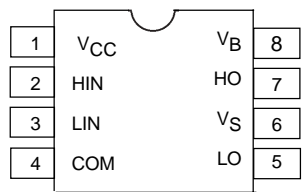
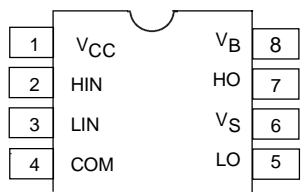
Functional Block Diagrams

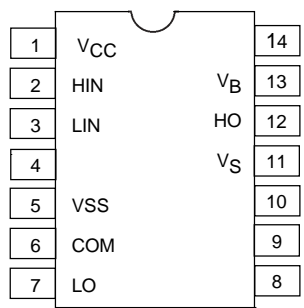
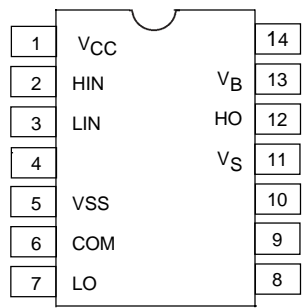


Lead Definitions

Symbol	Description
HIN	Logic input for high-side gate driver output (HO), in phase
LIN	Logic input for low-side gate driver output (LO), in phase
VSS	Logic ground (IRS21064 only)
V _B	High-side floating supply
HO	High-side gate drive output
V _S	High-side floating supply return
V _{CC}	Low-side and logic fixed supply
LO	Low-side gate drive output
COM	Low-side return

Lead Assignments

 <p>8 Lead PDIP</p>	 <p>8 Lead SOIC</p>
IRS2106PbF	IRS2106SPbF

 <p>14 Lead PDIP</p>	 <p>14 Lead SOIC</p>
IRS21064PbF	IRS21064SPbF

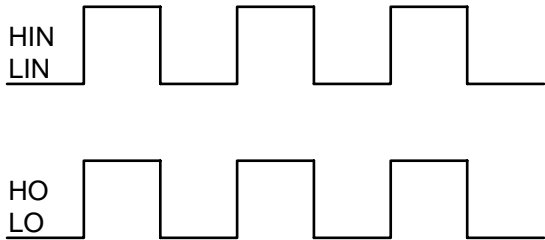


Figure 1. Input/Output Timing Diagram

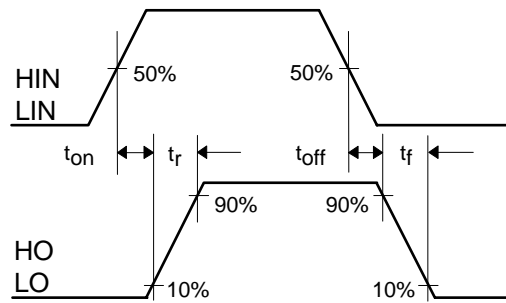


Figure 2. Switching Time Waveform Definitions

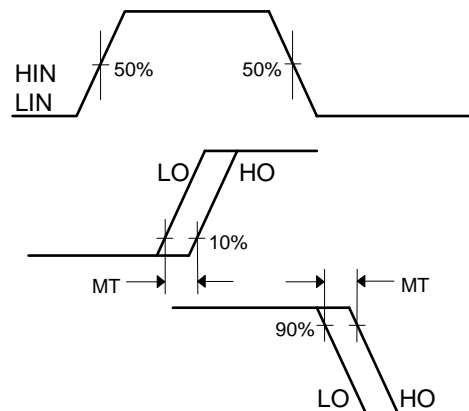


Figure 3. Delay Matching Waveform Definitions

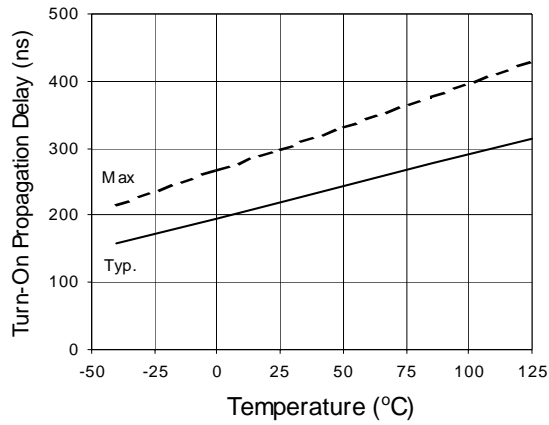


Figure 4A. Turn-On Propagation Delay vs. Temperature

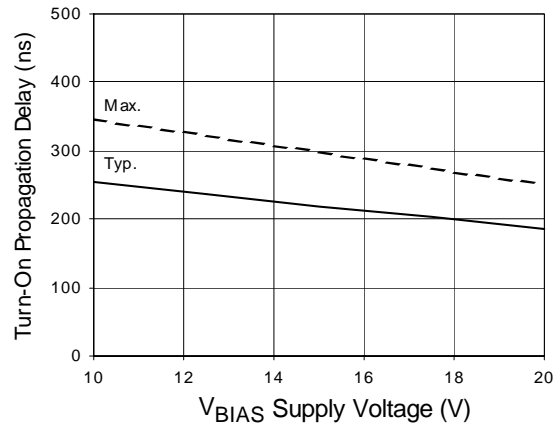


Figure 4B. Turn-On Propagation Delay vs. Supply Voltage

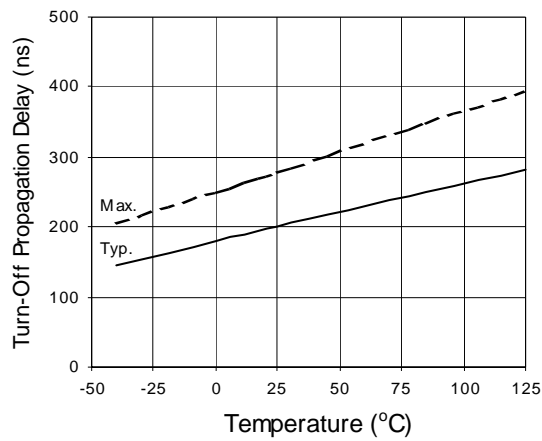


Figure 5A. Turn-Off Propagation Delay vs. Temperature

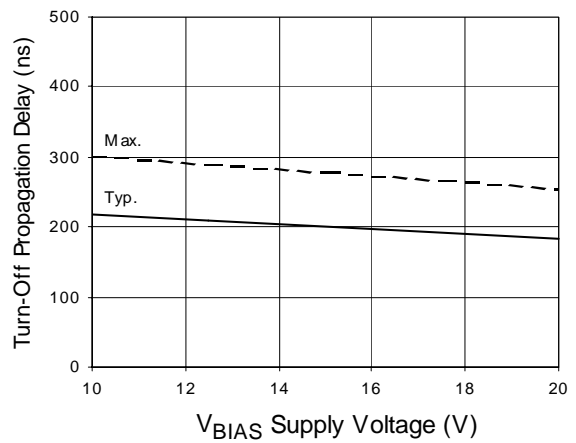


Figure 5B. Turn-Off Propagation Delay vs. Supply Voltage

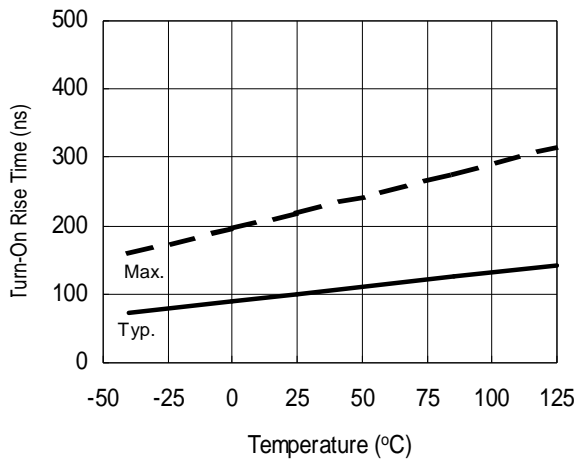


Figure 6A. Turn-On Rise Time vs. Temperature

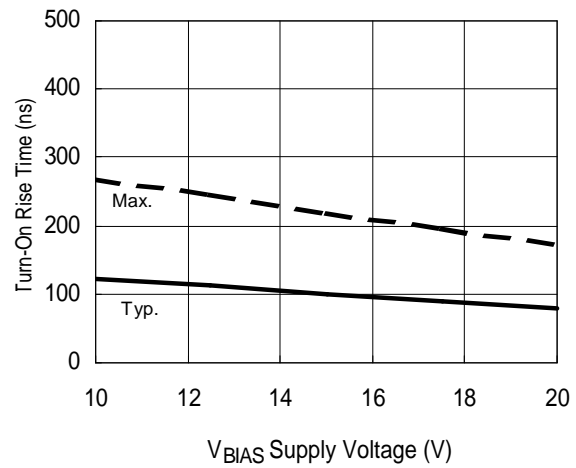


Figure 6B. Turn-On Rise Time vs. Supply Voltage

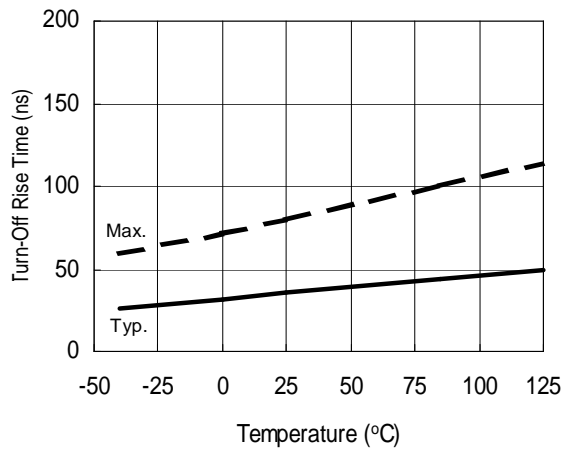


Figure 7A. Turn-Off Fall Time vs. Temperature

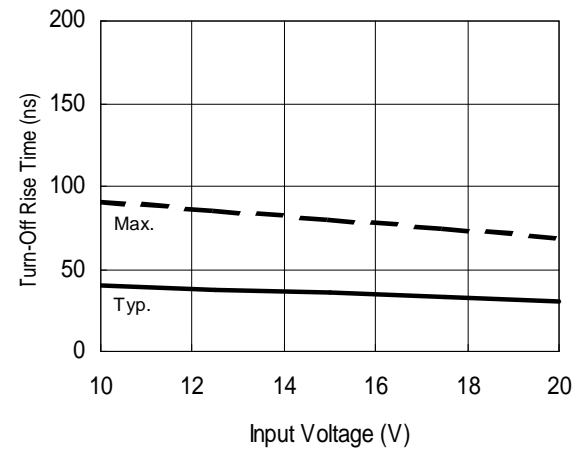


Figure 7B. Turn-Off Fall Time vs. Supply Voltage

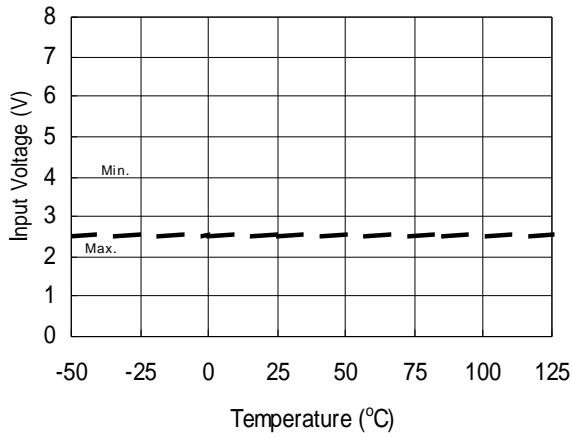


Figure 8A. Logic "1" Input Voltage vs. Temperature

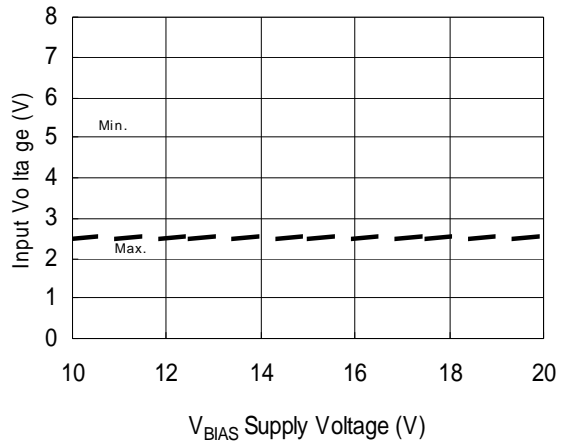


Figure 8B. Logic "1" Input Voltage vs. Supply Voltage

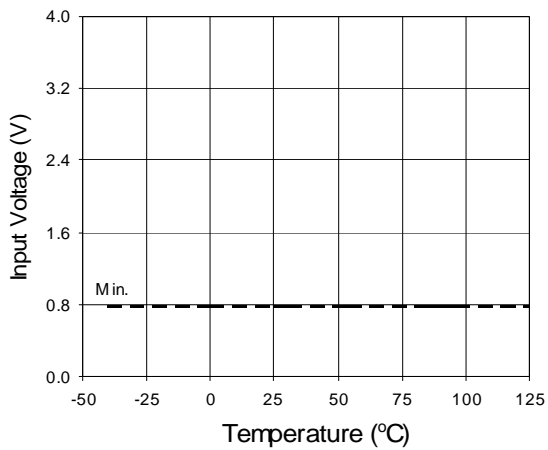


Figure 9A. Logic "0" Input Voltage vs. Temperature

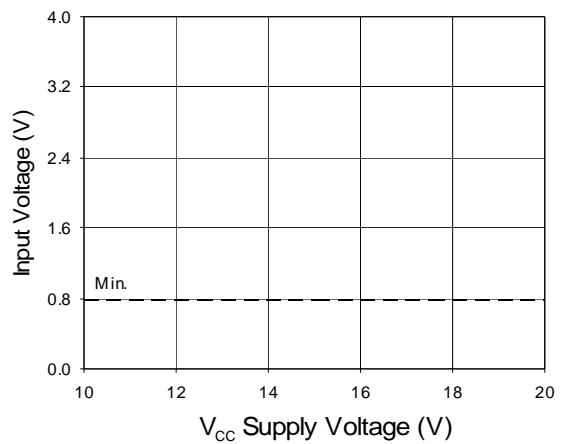


Figure 9B. Logic "0" Input Voltage vs. Supply Voltage

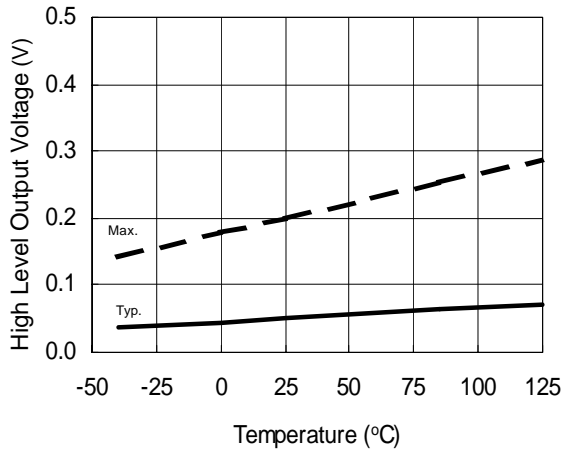


Figure 10A. High Level Output Voltage vs. Temperature

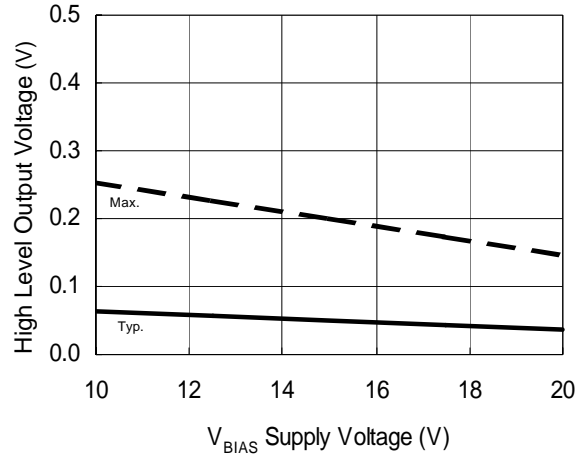


Figure 10B. High Level Output Voltage vs. Supply Voltage

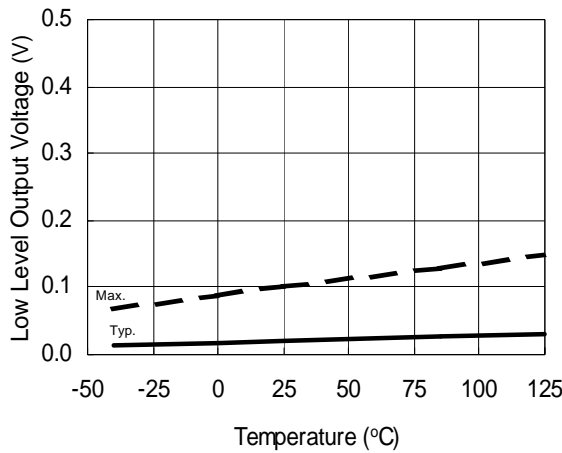


Figure 11A. Low Level Output Voltage vs. Temperature

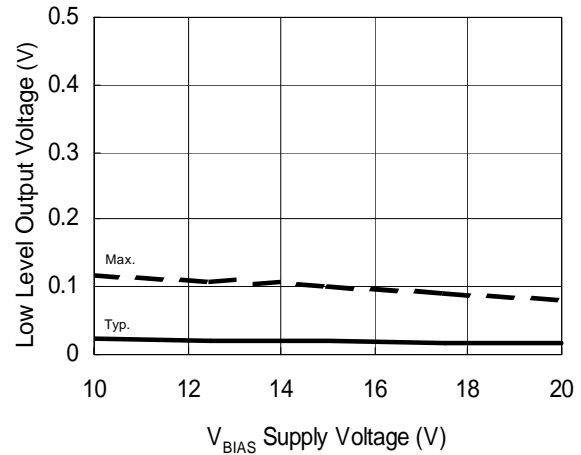


Figure 11B. Low Level Output Voltage vs. Supply Voltage

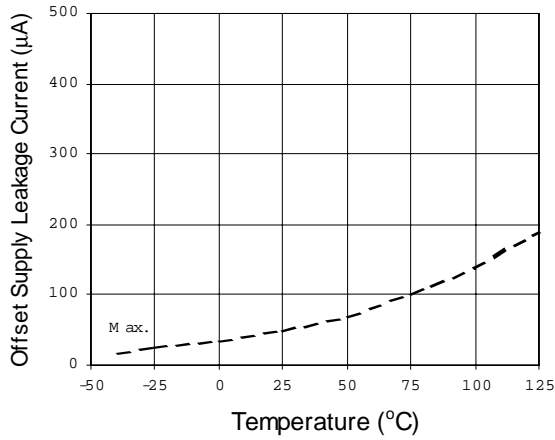


Figure 12A. Offset Supply Leakage Current vs. Temperature

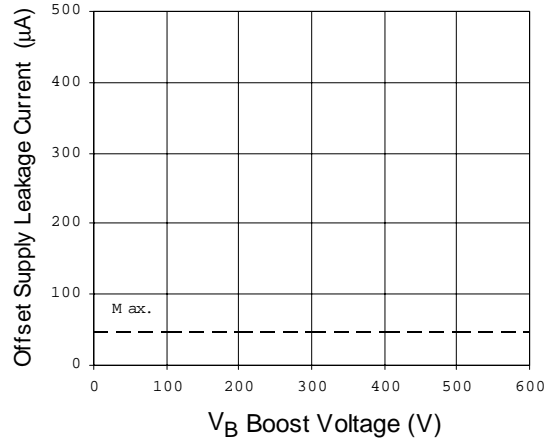


Figure 12B. Offset Supply Leakage Current vs. Supply Voltage

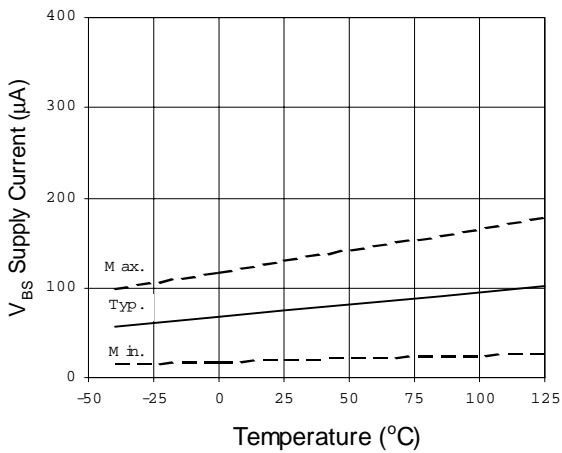


Figure 13A. V_{BS} Supply Current vs. Temperature

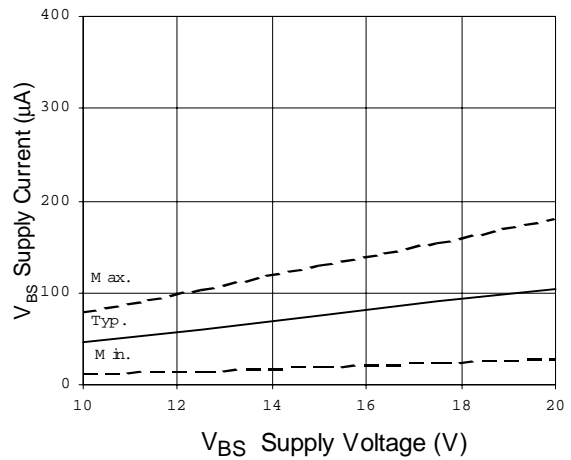


Figure 13B. V_{BS} Supply Current vs. Supply Voltage

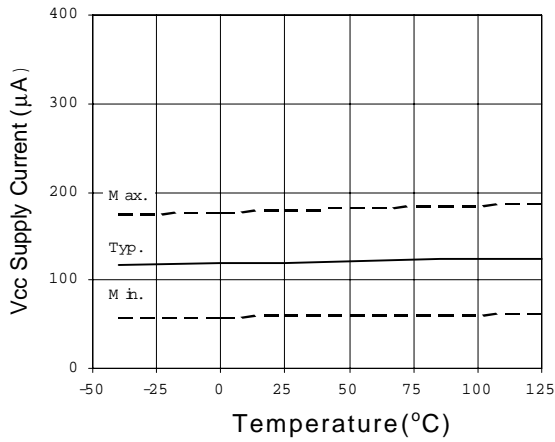


Figure 14A. Quiescent VCC Supply Current vs. Temperature

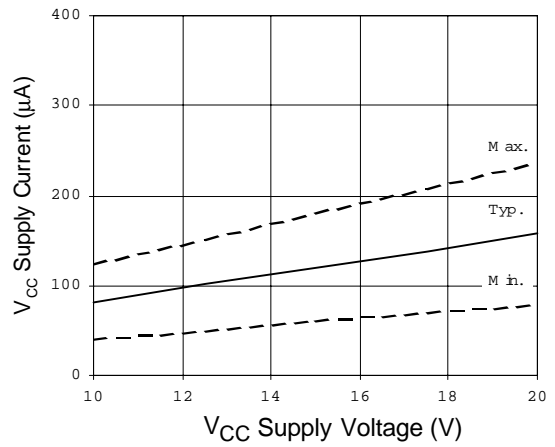


Figure 14B. Quiescent VCC Supply Current vs. VCC Supply Voltage

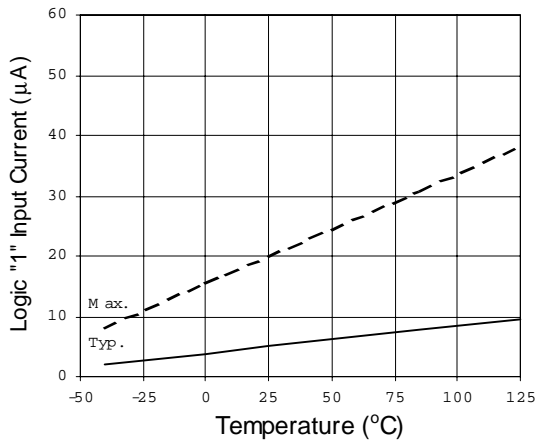


Figure 15A. Logic "1" Input Current vs. Temperature

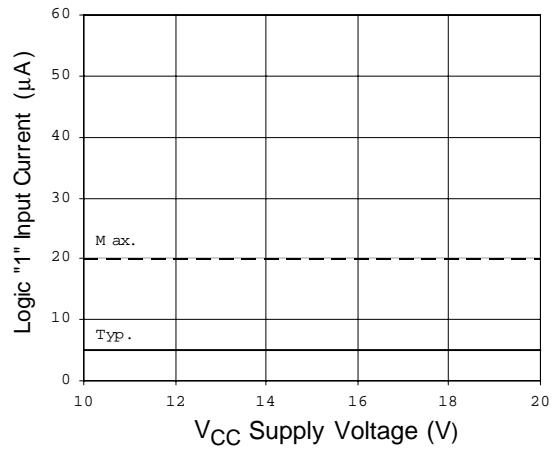


Figure 15B. Logic "1" Bias Current vs. Supply Voltage

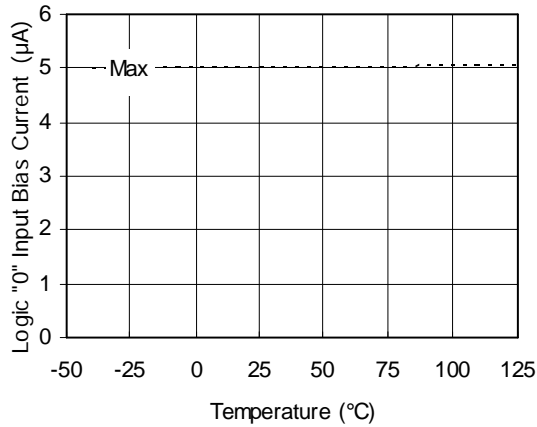


Figure 16A. Logic "0" Input Bias Current vs. Temperature

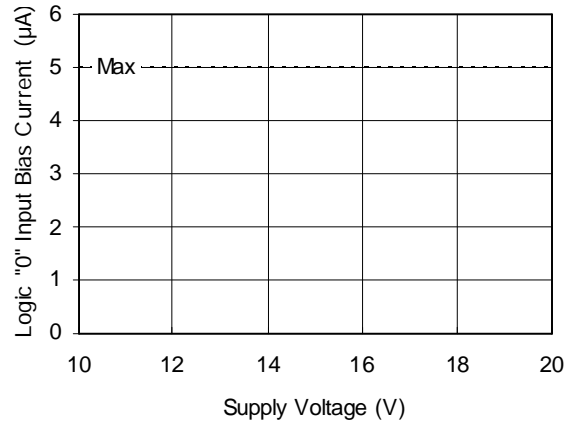


Figure 16B. Logic "0" Input Bias Current vs. Voltage

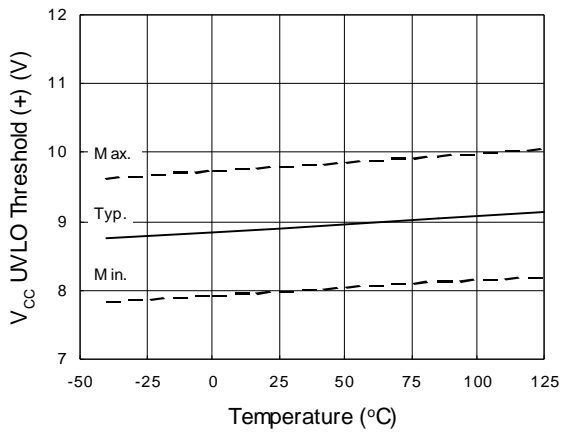


Figure 17. V_{CC} Undervoltage Threshold (+) vs. Temperature

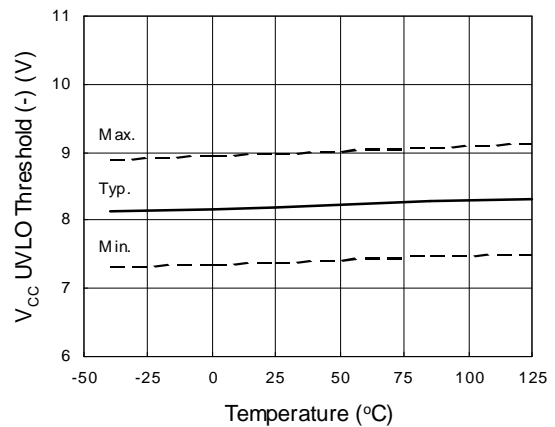


Figure 18. V_{CC} Undervoltage Threshold (-) vs. Temperature

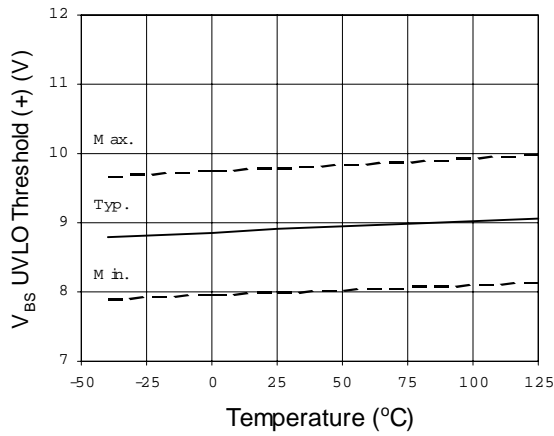


Figure 19. V_{BS} Undervoltage Threshold (+) vs. Temperature

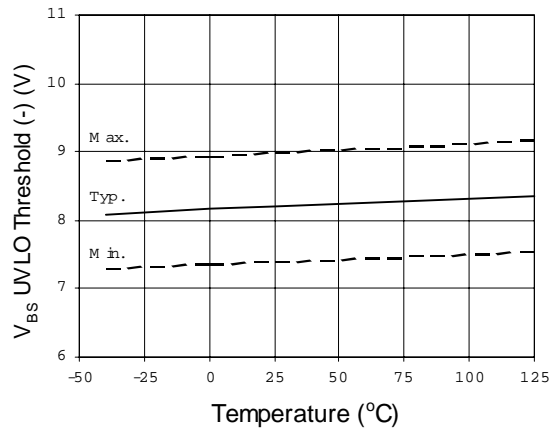


Figure 20. V_{BS} Undervoltage Threshold (-) vs. Temperature

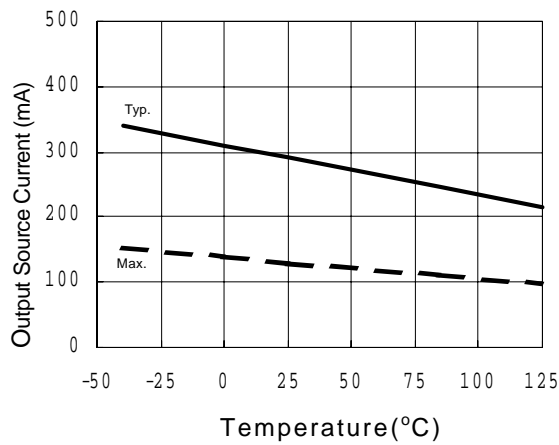


Figure 21A. Output Source Current vs. Temperature

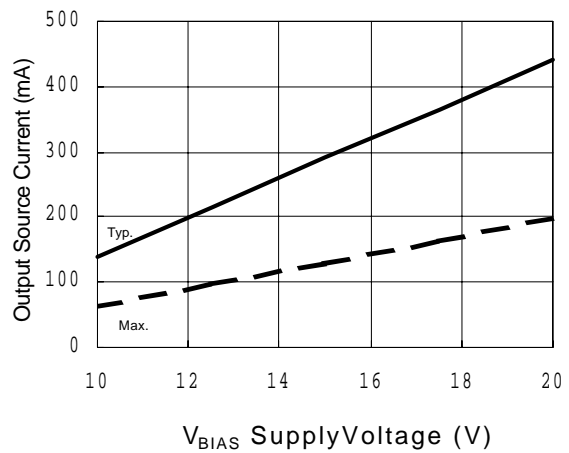


Figure 21B. Output Source Current vs. Supply Voltage

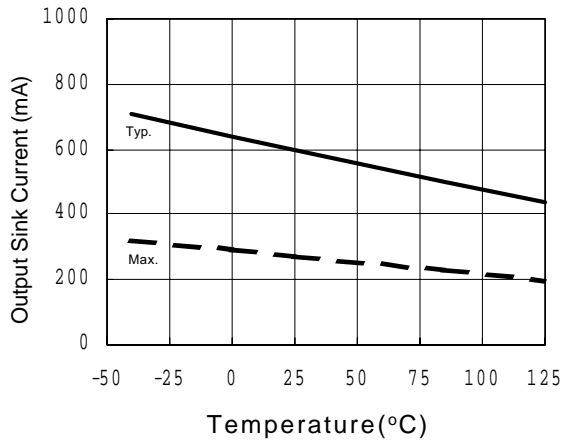


Figure 22A. Output Sink Current vs. Temperature

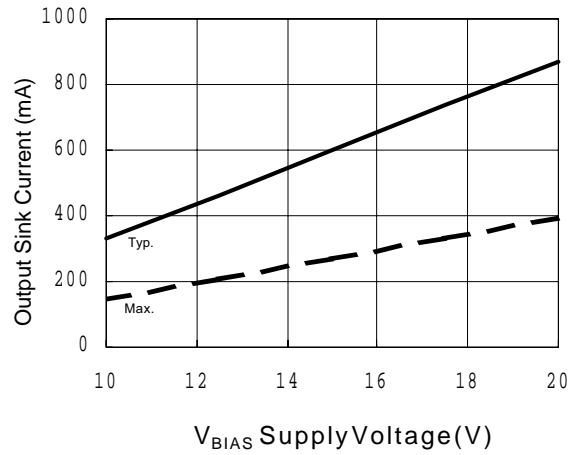


Figure 22B. Output Sink Current vs. Supply Voltage

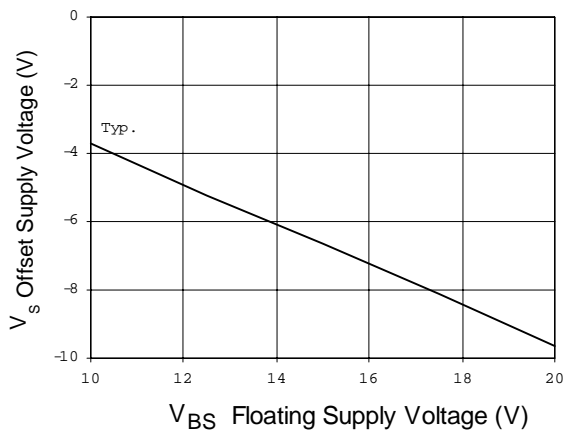


Figure 23. Maximum V_S Negative Offset vs. Supply Voltage

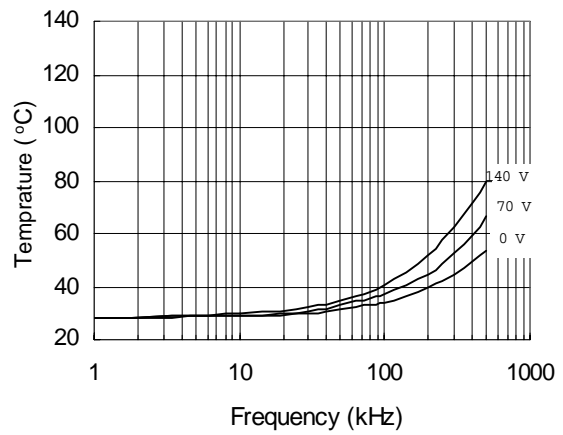


Figure 24. IRS2106 vs. Frequency (IRFBC20), R_{gate}=33 Ω, V_{CC}=15 V

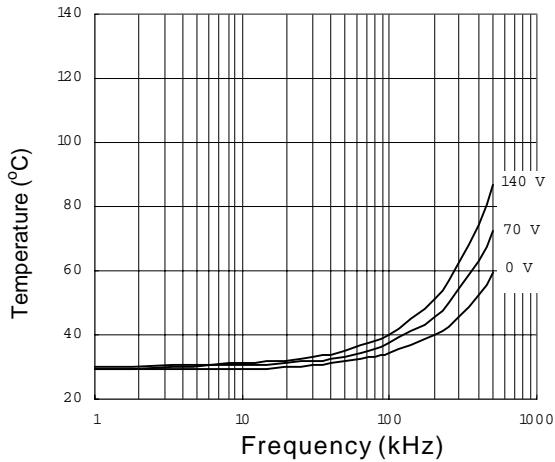


Figure 25. IRS2106 vs. Frequency (IRFBC30),
 $R_{gate}=22 \Omega$, $V_{CC}=15 V$

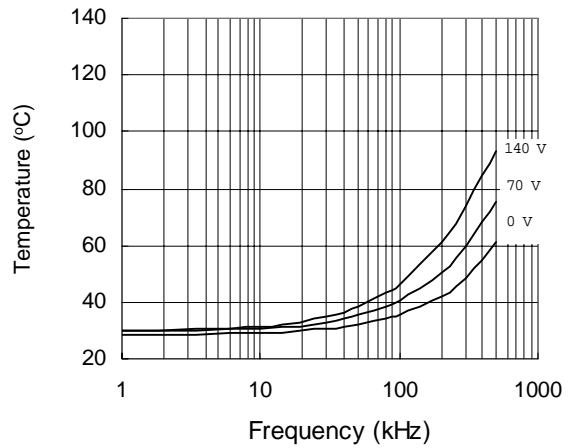


Figure 26. IRS2106 vs. Frequency (IRFBC40),
 $R_{gate}=15 \Omega$, $V_{CC}=15 V$

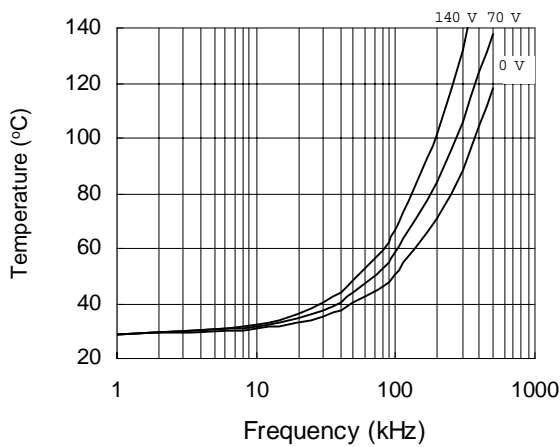


Figure 27. IRS2106 vs. Frequency (IRFPE50),
 $R_{gate}=10 \Omega$, $V_{CC}=15 V$

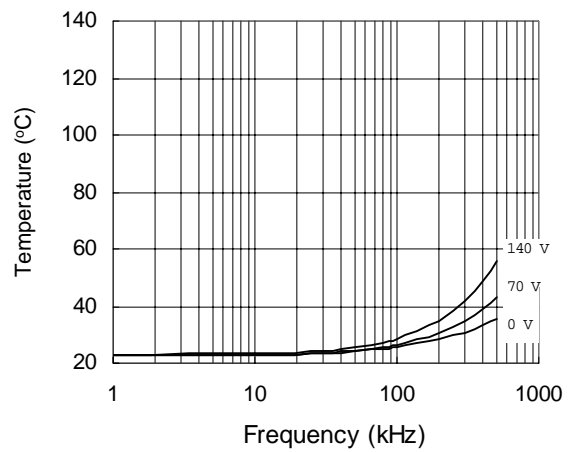
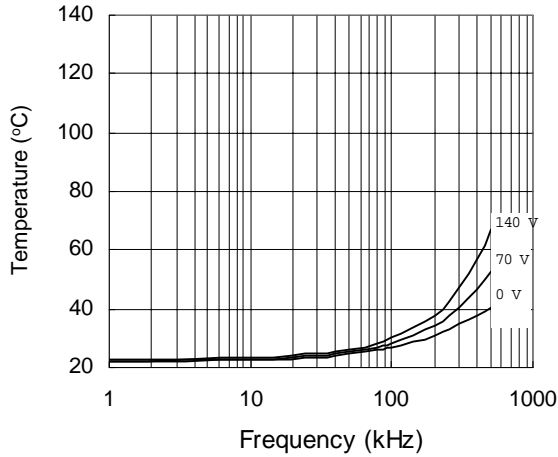
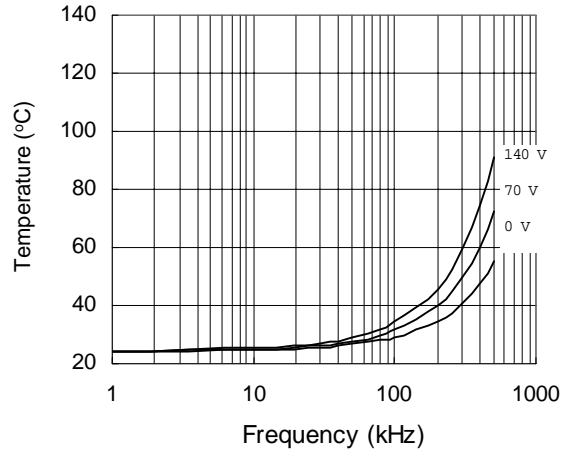


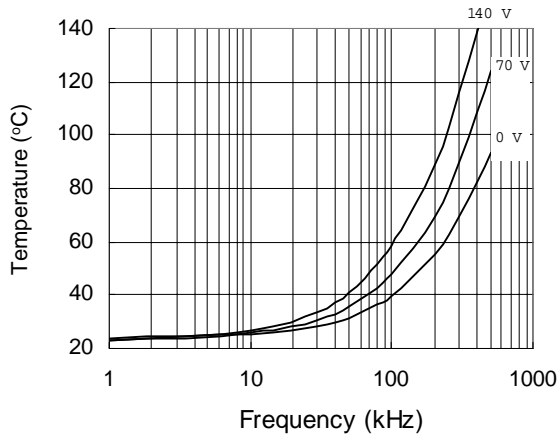
Figure 28. IRS21064 vs. Frequency (IRFBC20),
 $R_{gate}=33 \Omega$, $V_{CC}=15 V$



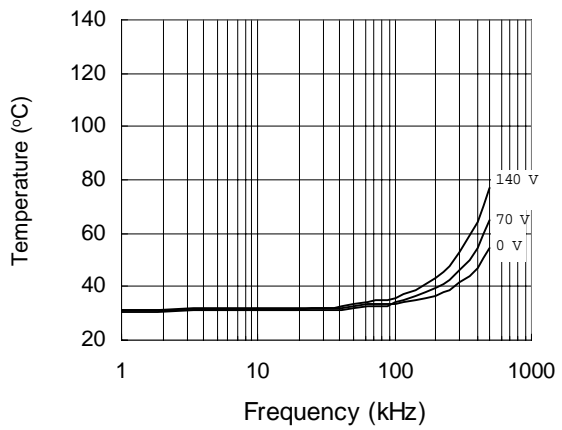
**Figure 29. IRS21064 vs. Frequency (IRFBC30),
 $R_{gate}=22 \Omega, V_{CC}=15 V$**



**Figure 30. IRS21064 vs. Frequency (IRFBC40),
 $R_{gate}=15 \Omega, V_{CC}=15 V$**



**Figure 31. IRS21064 vs. Frequency (IRFPE50),
 $R_{gate}=10 \Omega, V_{CC}=15 V$**



**Figure 32. IRS2106S vs. Frequency (IRFBC20),
 $R_{gate}=33 \Omega, V_{CC}=15 V$**

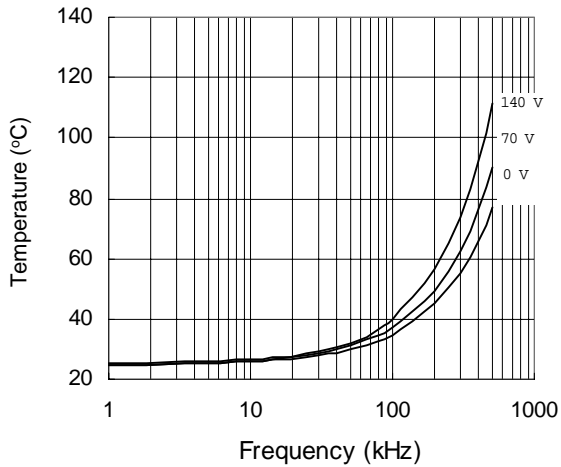


Figure 33. IRS2106S vs. Frequency (IRFBC30),
 $R_{gate}=22\ \Omega$, $V_{CC}=15\ V$

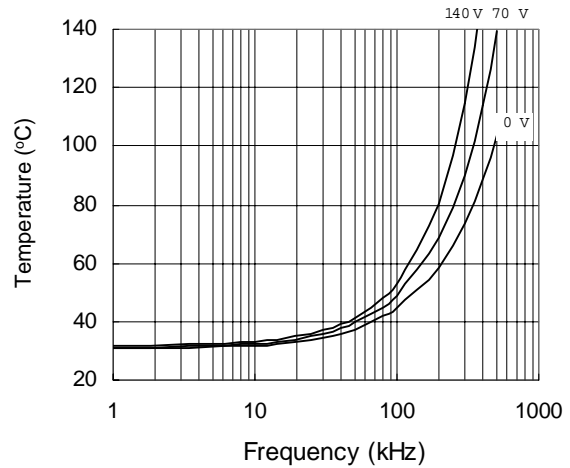


Figure 34. IRS2106S vs. Frequency (IRFBC40),
 $R_{gate}=15\ \Omega$, $V_{CC}=15\ V$

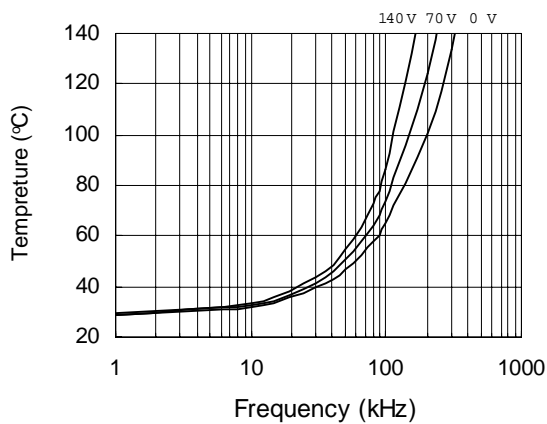


Figure 35. IRS2106S vs. Frequency (IRFPE50),
 $R_{gate}=10\ \Omega$, $V_{CC}=15\ V$

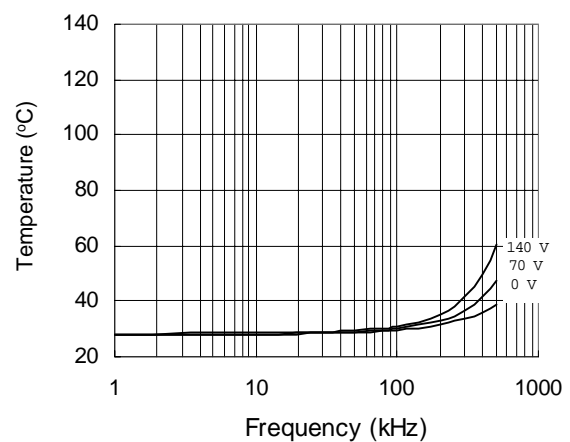
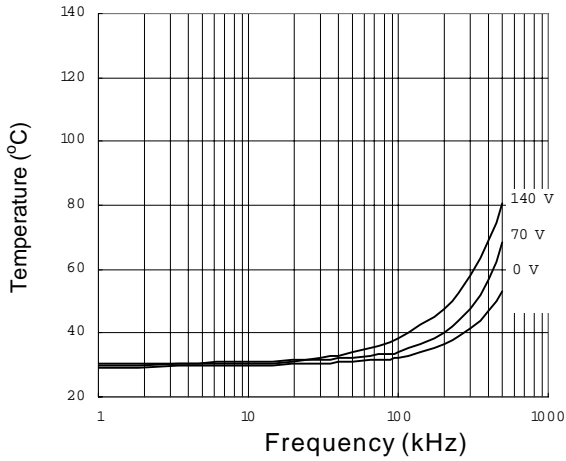
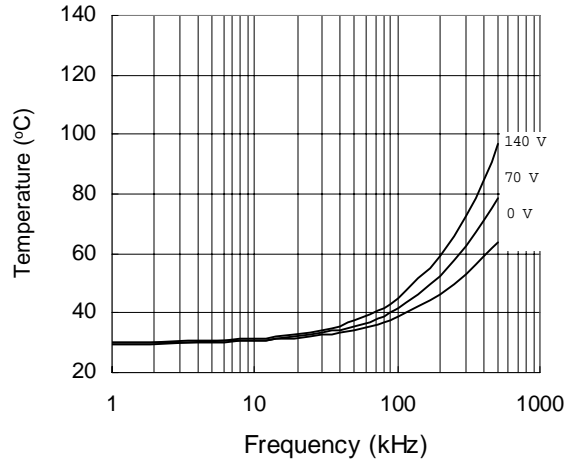


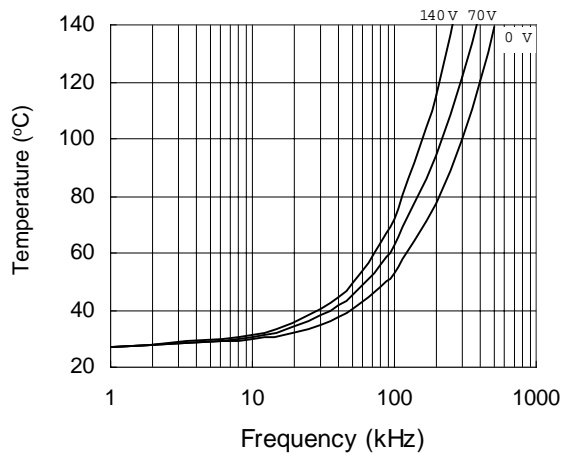
Figure 36. IRS21064S vs. Frequency (IRFBC20),
 $R_{gate}=33\ \Omega$, $V_{CC}=15\ V$



**Figure 37. IRS21064S vs. Frequency (IRFBC30),
 $R_{gate}=22 \Omega$, $V_{CC}=15 V$**

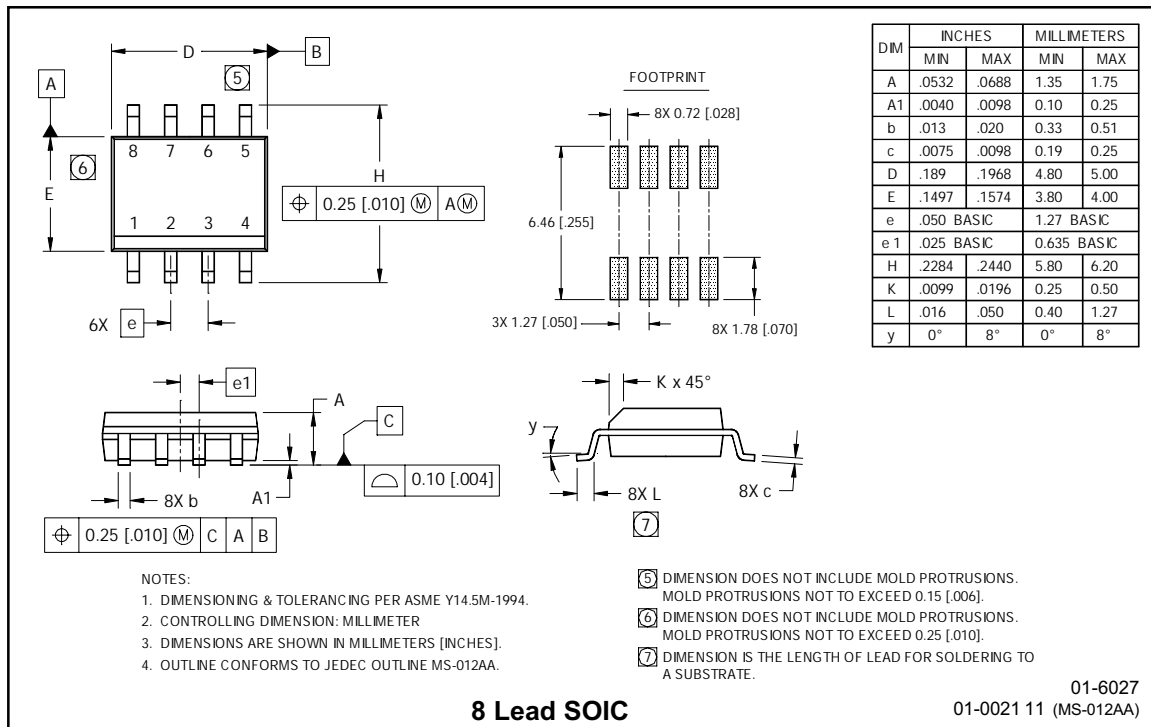
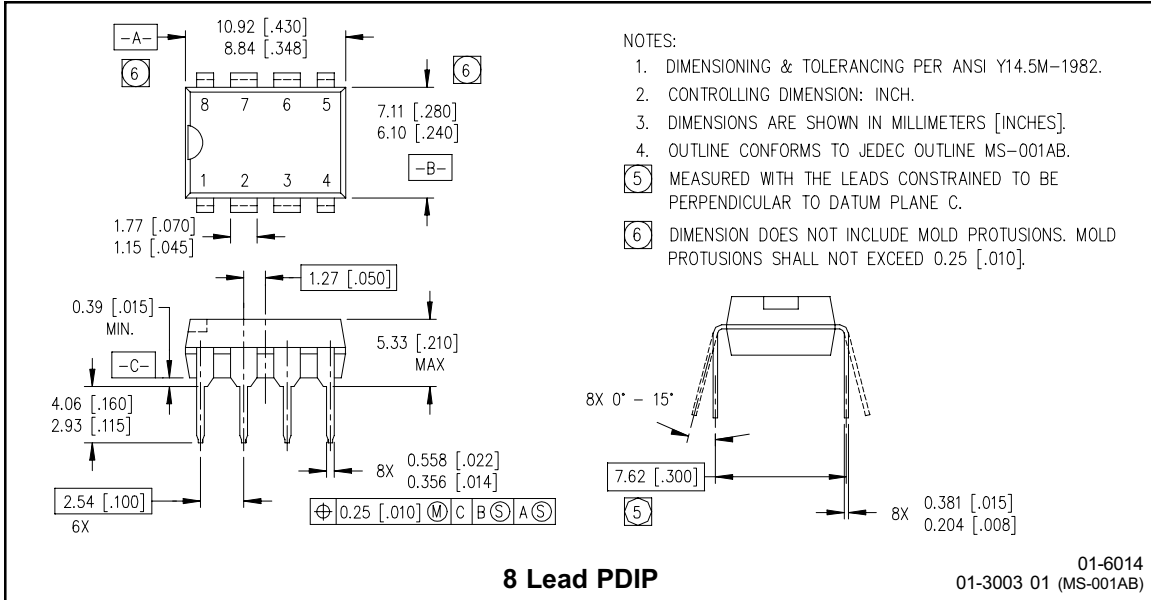


**Figure 38. IRS21064S vs. Frequency (IRFBC40),
 $R_{gate}=15 \Omega$, $V_{CC}=15 V$**



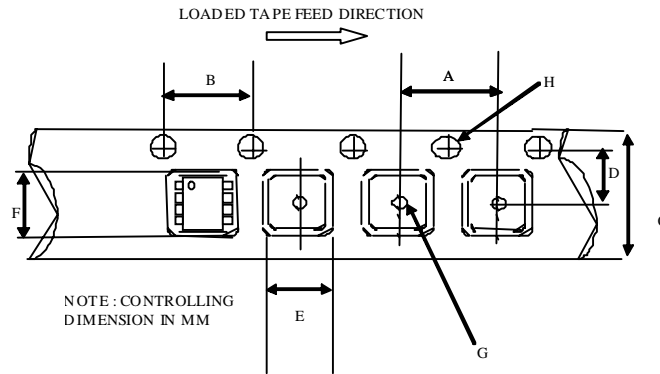
**Figure 39. IRS21064S vs. Frequency (IRFPE50),
 $R_{gate}=10 \Omega$, $V_{CC}=15 V$**

Case Outlines





Tape & Reel 8-lead SOIC



CARRIER TAPE DIMENSION FOR 8SOICN

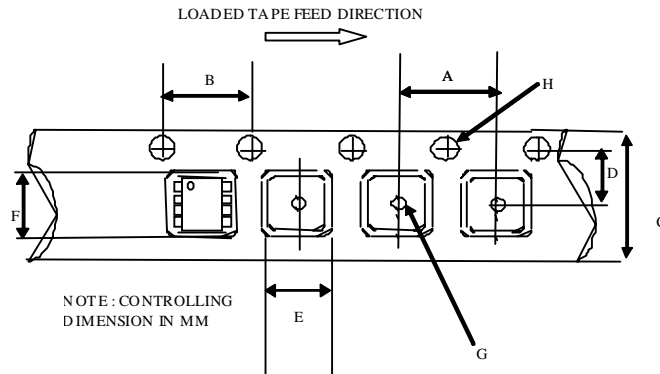
Code	Metric		Imperial	
	Min	Max	Min	Max
A	7.90	8.10	0.311	0.318
B	3.90	4.10	0.153	0.161
C	11.70	12.30	0.46	0.484
D	5.45	5.55	0.214	0.218
E	6.30	6.50	0.248	0.255
F	5.10	5.30	0.200	0.208
G	1.50	n/a	0.059	n/a
H	1.50	1.60	0.059	0.062



REEL DIMENSIONS FOR 8SOICN

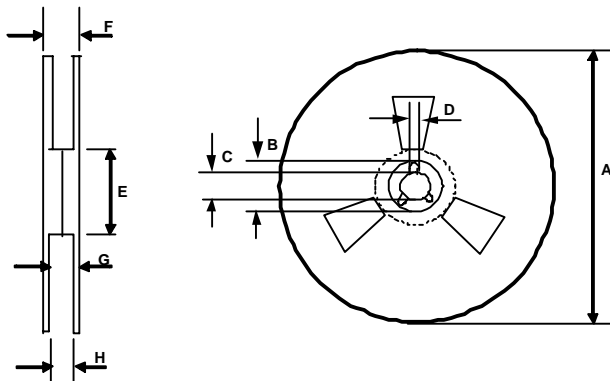
Code	Metric		Imperial	
	Min	Max	Min	Max
A	329.60	330.25	12.976	13.001
B	20.95	21.45	0.824	0.844
C	12.80	13.20	0.503	0.519
D	1.95	2.45	0.767	0.096
E	98.00	102.00	3.858	4.015
F	n/a	18.40	n/a	0.724
G	14.50	17.10	0.570	0.673
H	12.40	14.40	0.488	0.566

Tape & Reel 14-lead SOIC



CARRIER TAPE DIMENSION FOR 14SOICN

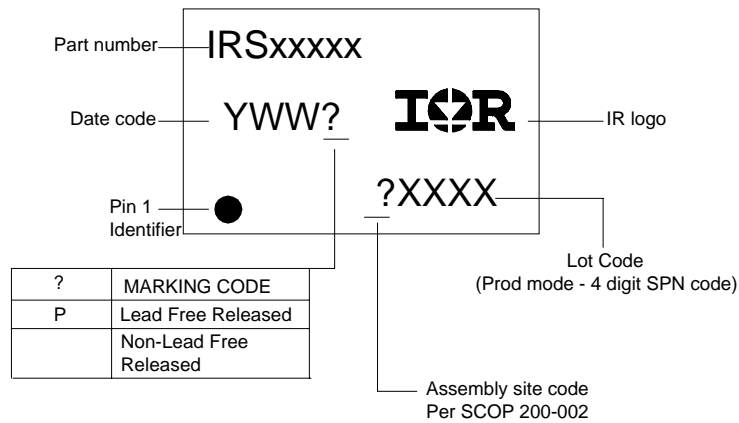
Code	Metric		Imperial	
	Min	Max	Min	Max
A	7.90	8.10	0.311	0.318
B	3.90	4.10	0.153	0.161
C	15.70	16.30	0.618	0.641
D	7.40	7.60	0.291	0.299
E	6.40	6.60	0.252	0.260
F	9.40	9.60	0.370	0.378
G	1.50	n/a	0.059	n/a
H	1.50	1.60	0.059	0.062



REEL DIMENSIONS FOR 14SOICN

Code	Metric		Imperial	
	Min	Max	Min	Max
A	329.60	330.25	12.976	13.001
B	20.95	21.45	0.824	0.844
C	12.80	13.20	0.503	0.519
D	1.95	2.45	0.767	0.096
E	98.00	102.00	3.858	4.015
F	n/a	22.40	n/a	0.881
G	18.50	21.10	0.728	0.830
H	16.40	18.40	0.645	0.724

LEADFREE PART MARKING INFORMATION



ORDER INFORMATION

8-Lead PDIP IRS2106PbF	14-Lead PDIP IRS21064PbF
8-Lead SOIC IRS2106SPbF	14-Lead SOIC IRS21064SPbF
8-Lead SOIC Tape & Reel IRS2106STRPbF	14-Lead SOIC Tape & Reel IRS21064STRPbF

International
IR Rectifier

The SOIC-8 is MSL2 qualified.
 The SOIC-14 is MSL3 qualified.

This product has been designed and qualified for the industrial level.

Qualification standards can be found at www.irf.com

IR WORLD HEADQUARTERS: 233 Kansas St., El Segundo, California 90245 Tel: (310) 252-7105
 Data and specifications subject to change without notice. 12/4/2006